

# QUALITY GUIDE



QUALITY, FUNCTION & PLANNING TIPS

# QUALITY & FUNCTION





As you know, competent and effective customer service is essential to successful sales. This includes sound product knowledge that goes beyond what is in the general sales documents, leaflets and image brochures. This QUALITY GUIDE is a comprehensive compendium of "273 good reasons" to choose a nobilia kitchen.

The Quality Guide provides you with answers to pivotal questions so that you are well prepared for sales consultations. We will show you what makes a nobilia kitchen so valuable: an intelligent and practical design of the individual components in addition to sophisticated fittings and functional technology with superior quality!

From the quality to the distinctive features and characteristics of the different materials and surfaces to the planning specifics and special installation aids: We have compiled the most important information about nobilia in this comprehensive guide. In the chapter QC Laboratory, we also introduce you to the preventative tests as well as load tests and testing methods used during series production, which nobilia kitchens must pass. We hope you enjoy reading this Quality Guide.

THE CARCASE	4   5
PRODUCT FEATURES OF CABINETS	6   7
PLINTH FEET   PLINTH PANELS	8   9
HINGE TECHNOLOGY   HINGED DOORS	10   11
DRAWER AND PULL-OUT SYSTEM	12   13
CARCASE DÉCORS   FRONTS	14   15
WORKTOPS   UPRIGHT PANELS	16   17
DIMENSION®	18   19
SYSTEM GRID   PERFECT ERGONOMICS	20   23
THE HANDLE-LESS KITCHEN LINE N	24   25
DISTINCTIVE FEATURES OF PLANNING LINE N	26   27
DRAWER ORGANISERS   PULL-OUT ORGANISERS	28   31
INDIVIDUALISED COMFORT	32   33
CORNER UNITS	34   35
DOWNDRAFT EXTRACTOR FANS	36   37
TALL UNITS   HIGHBOARDS	38   39
WALL UNITS   DRESSER UNITS	40   41
WALL UNITS   WALL UNIT FITTINGS	42   43
INTEGRATED LIGHTED DESIGNS   EMOTION TECHNOLOGY	44   45
AMBIENT LIGHTING   SOCKETS   USB CHARGER	46   47
COLOR CONCEPT   SHELF UNIT BACK PANELS   PANEL WALL SETS	48   49
NICHE CLADDINGS	50   51
NICHE ACCESSORIES   BASE UNITS WITH SPECIAL HEIGHTS	52   53
OPEN SHELF UPRIGHT SYSTEM	54   57
PACKING   INSTALLATION	58   59
QC-TEST LABORATORY	60   71
PRODUCT STRATEGY   DESIGN	72   73
ADMINISTRATIVE SERVICES   FIELD SERVICES   MARKETINGPRODUKTION	74   75
PRODUCTION MADE IN GERMANY	76   77
QUALITY   ENVIRONMENT   CERTIFICATES	78   79

# THOROUGHLY WELL-MADE

nobilia uses highly automated series production to manufacture more than 2300 types of cabinets. The manufacturing base is the **dimension®** modular system with three base unit heights, five wall unit heights, four dresser unit heights, four tall unit heights and three special heights for multi-functional designs.

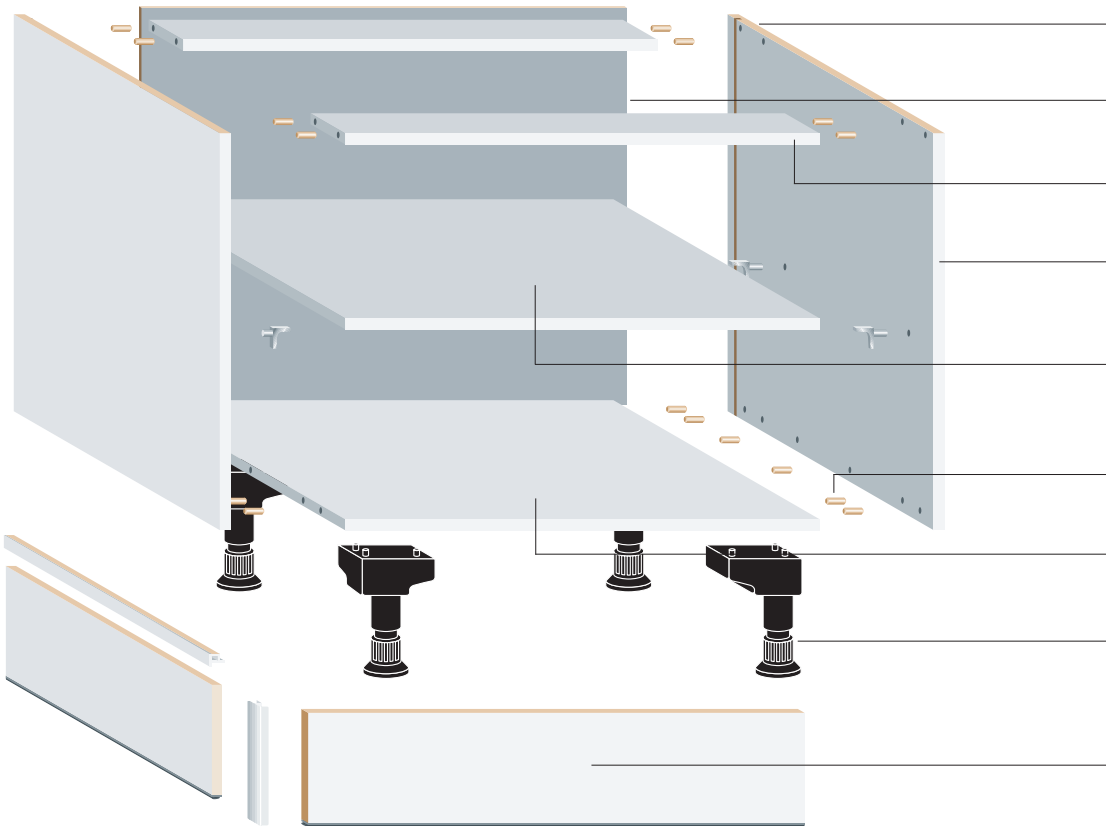

Side panels 16 mm thick,  
both faces melamine direct coated

Back panels 2.8 mm hardboard, both faces  
lacquered, screw-mounted to carcass

Crossbars 19 mm thick,  
both faces melamine direct coated

Carcass front edges  
with PP thick edging (1.2 mm thick)

Shelf, 16 mm thick,  
front edge with PP thick edging (1.2 mm thick)

Shelf and side panels glued in  
with hardwood dowels (8 x 30 mm)

Construction shelf 19 mm thick,  
both faces melamine direct coated

Plinth feet with height adjustment  
-10 and + 20 mm

MDF plinth panels  
with floor profile  
70 mm, 100 mm, 150 mm, 200 mm  
13 mm thick, melamine coated

## 1 CARCASS MATERIAL 16 MM

Side panels 16 mm thick,  
both faces melamine direct  
coated - thus, extremely  
durable and easy-care.



## 6 ALL METAL SHELF SUPPORTS

All metal shelf supports with  
locking pin, high load-bearing  
capacity in accordance with  
DIN standard. The locking pin  
prevents the shelves from  
shifting. Maximum load for  
wooden and glass shelves:  
50 kg/m<sup>2</sup>.



Minimises complaints



Load capacity



Easy to assemble



Great value

## 2 FRONT EDGE OF CARCASE/ SHELVES

Carcase front edge and shelves coated with PP thick edging 1.2 mm. Extremely resilient and impact resistant. Attractive appearance due to soft rounding.

## 3 CONSTRUCTION SHELVES/ CROSSBARS 19 MM

Extremely sturdy construction shelves and crossbars for base and tall units. Top crossbars for base units: white edge colour for a uniformed appearance.

## 4 MOISTURE DOESN'T STAND A CHANCE HERE

Edges on shelves and side panels sealed all round to ensure a clean finish and prevent penetration of dirt and moisture.



## 5 HARDWOOD DOWELS 8 X 30 MM

Shelves, construction shelves and side panels are glued in with hardwood dowels.



The high quality construction of the carcase elements in addition to the well-thought out fittings technology is the result of many years of experience and continual process improvements in the production flow.

Uwe Schirmer,  
Employee in the Product  
Development department

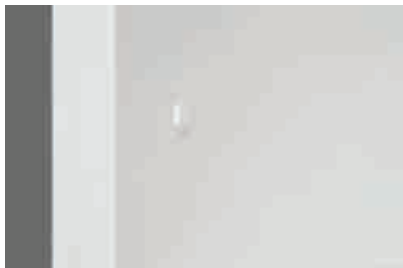
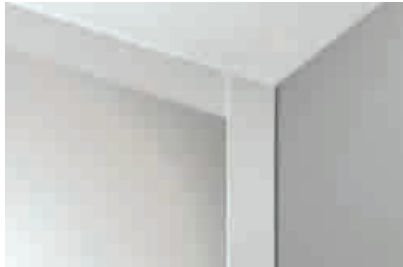

## 7 COVER PLUGS

Perfection, even inside the unit: The 5 mm drill holes can optionally be closed with plastic cover plugs. These are perfectly matched to the colour of the carcase interior.

## 8 GLASS SHELVES

Glass wall units come standard with a 5 mm glass shelf for a uniform, transparent appearance. Units with swivel flap doors and folding-lifting doors have 6 mm thick glass shelves.

## 9 50 KG PER M<sup>2</sup> SHELF LOAD CAPACITY

It all fits!  
All shelves (including loose shelves) can hold a load of up to 50 kg/m<sup>2</sup>. This is equivalent to, for instance, over 80 dinner plates.



## 10 REAR PANELS OFFSET TOWARD FRONT

2.8 mm HDF board, treated with protective lacquer coating on both faces. Back panels are also screw-mounted to the carcase in 6 mm deep grooved sides. Protruded back panels ensure good air circulation between the wall and kitchen furniture and thus will not get damp.

Advantages: No interior gap formation visible. Long-lasting, permanently sturdy, yet variable for the fitter on site. Both faces are lacquered, which prevents moisture absorption, and is thus mould-resistant.



← 561 MM →  
 ← 522 MM →

## IT'S WHAT IS INSIDE THAT COUNTS!

### 11 IT ALL FITS!

- Carcase depth for base and tall units: 561 mm
- Useable depth: 522 mm
- Maintenance-free fittings/easy-to-assemble

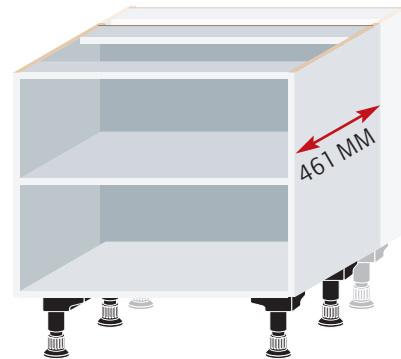

### 12 SIDE DEPTH 461 MM WITHOUT SURCHARGE

The side depth of 461 mm provides planning flexibility for planning of narrow room layouts without surcharges for custom productions.



### 13 MOISTURE PROTECTION SHELF

Optional: The moisture protection sheet for sink units and units subjected to tough conditions, for instance broom cupboards, prevents scratching of the bottom shelf by vacuums and other devices. Residual moisture protection for buckets, brooms or cleaning products.



### 14 STURDY METAL CROSSBARS

Cooker housing units, sink units, carousel corner unit and 1200 mm wide base units are exceptionally sturdy due to integrated metal cross members.

The quality of kitchen components is not usually in the foreground, but rather concealed in the interior, and yet it is so important. This holds true for metal crossbars, protection panels and metal shelves that lend the design stability and durability.

Andreas Bielefeld,  
Director of Product Management



## 15 FULLY USABLE

The metal grid in sink pull-out units can be freely positioned. Thus, a recess for the sink waste pipe is not necessary and the pull-out is fully usable.



## 16 STEAM PROTECTION PLATE DISHWASHERS

Tall units for raised dishwashers come standard with an extra deep steam protection plate.



## 17 STEAM PROTECTION PLATE WALL UNITS

Here, the heat doesn't stand a chance: optional steam protection plate for wall units adjacent to the cooker hood (DDS/4502).



## 18 CORNER BASE UNITS CAN BE DISASSEMBLED

Corner base units can be disassembled on site (i.e. UEK 90). This allows them to fit through even tight stairwells and narrow doors.



## THE PLINTH - STEADY!

### PLINTH ADAPTER

200 MM

150 MM

100 MM

70 MM

20 MM

10 MM



### 19 4 STANDARD- PLINTH HEIGHTS

- The sturdy plinth construction with adapters and feet comes in the standard heights 70, 100, 150 and 200 mm.
- Adjustable range: -10 to +20 mm
- Intermediate heights (10 and 20 mm) are possible with adapter, see Sales Manual, chapter 3, MP-SO (order no. 4187).

- Plinth feet independently adjustable. Ideal for uneven tiled floors, as the cabinet always stands straight!
- Load capacity: 250 kg per unit /4 feet.



Also suitable for use with granite worktops.

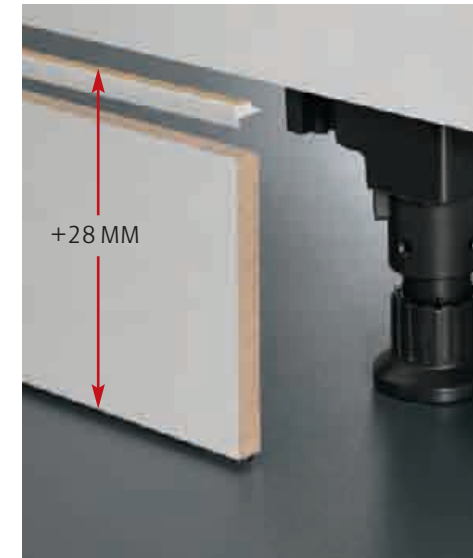

### 20 PLINTH RETURNS 28 MM ADDED

The fitters will be happy: By adding another 28 mm to plinth returns the fitter can adjust the panel on site.







21 | PLINTH PANELS 13 MM

Plinth panels are produced from 13 mm MDF (= medium density fibreboard) and are direct coated. This makes them extremely resilient and easy to care for.

22 | JUST TO MAKE SURE

Stand-alone base units must always be equipped with safety bracket KIPPS. It is available in two designs and is supplied automatically with stand-alone base units at a surcharge.



23 | FLEXIBLE FLOOR SEALING PROFILE

Plinth panels with attached floor profile form an elegant closure with the floor and prevent the ingress of moisture and dirt into the plinth area. The profile included in delivery compensates for uneven floors with deviations of up to 2 mm.



24 | WATERPROOF PLINTH PANEL

The profile SB-PROFIL (order no. 4863) must be ordered separately to compensate for uneven floors with larger deviations. On uneven floors, precise height and width adjustments are only possible on site!

Waterproof plinth panels with stainless steel appearance or foil-coated mirror décor are available for a surcharge. They are useful everywhere where it is particularly humid and damp, and they look great as well.



25 | LIGHTWEIGHT AND AIRY - OPEN PLINTH SYSTEMS

In conjunction with 25 mm thick upright panels different plinth feet can be used for elements. All feet can be individually height adjusted.

26 | TERRIFIC EFFECT - PLINTH LIGHTING

This is how to highlight plinths: with the LED plinth light that can be individually mounted or with the Flex LED flexible light tape.

# Sensys

## PERFECT CUSHIONING, FLAWLESS DESIGN

The standardised introduction of SENSYS means even more quality and perfection in the hinge technology from nobilia kitchens. The multi award-winning SENSYS hinge with integrated cushioning from Hettich represents the latest generation of hinge technology on the market. All nobilia kitchens, from entry level to the high end segment, are equipped with SENSYS as standard at no surcharge. In this way, the company provides innovative technology with excellent value for money.

SENSYS has already been distinguished with the "red dot design award 2008" and the "iF product design award 2009" for its excellent design.



reddot design award  
winner 2008

### 27 CLOSING COMFORT WITH EASE

The doors close with just a light movement of your hand – smoothly and silently. The unique, automatic self-closing device ensures secure closure upwards of an angle of 35°.

### 28 SILENT SYSTEM CUSHIONING

SENSYS hinges are equipped as standard with the SILENT SYSTEM integrated cushioning system. SENSYS always closes reliably, while providing cushioning for doors of varying sizes and weights.



### 29 AWARD-WINNING DESIGN

Discreet lines from the hinge cup to the mounting plates ensure a modern hinge design. All edges and radii coordinate perfectly with one another for a harmonious overall look. The Silent System cushioning is as invisible as the release tab of the hinge.



### 30 RELIABLE QUALITY

SENSYS ensures smooth, even closure within an unusually high temperature range of +5°C to +40°C as well as at a relative humidity of 90 percent. With at least 80,000 tested cycles, SENSYS stands for reliability and long service life.



### 31 INSTALLATION-FRIENDLY

Assembles or disassembles quickly and easily without tools by pressing lightly with your finger on the concealed release tab. Then, in one smooth, ergonomic movement the hinge is released from the release tab and hinge arm.

## 32 PERFECT ADJUSTMENT

SENSYS hinges are three-dimensionally adjustable. Thus, SENSYS always provides a perfect gap pattern in the kitchen, even on thick doors with small radii.



## 33 DOOR HINGE BUFFER

All fronts are cushioned as standard with 2 mm thick plastic bumpers on the door interior.



## 34 110° - HINGE FOR HINGED DOORS

Hinged doors are equipped as standard with 110° hinges with integrated cushioning. The large opening angle provides convenient access, allowing you to reach even into back corners.

## 35 95° - HINGE FOR DIAGONAL CORNER UNITS

95°-hinges are used in diagonal corner units. The limited opening angle prevents contact with the door handle of the adjacent unit.

## 36 85° - OPENING ANGLE LIMITER

The opening angle limiter on 95° and 110° hinges ensures safety when planning corner solutions, wall unit attachments and glass doors adjacent to the cooker hood. The limited angle also prevents contact between handles on corner units.

## 37 165° WIDE ANGLE HINGE

Corner base units, corner wall units and units with internal drawers are equipped with 165° wide angle hinges at the factory and allow convenient access in tight corners. Opening angle limits (adjustable to 90° and 135°) are standard equipment.

## 38 PUSH-TO-OPEN SYSTEM

For handle-less planned kitchens, hinged doors can also optionally be equipped with the push-to-open system. The system can be retrofitted at any time.



# Profi<sup>+</sup>

MADE FOR THE FUTURE

## 39 METALLIC STEEL FRAME

The Profi<sup>+</sup> drawer system has an extremely high quality steel frame, that gives it a gorgeous modern and timeless look. The frame has a double-coated silver finish, the colour-coordinated bottom panel is 16 mm thick.

## 40 EXCEPTIONALLY SMOOTH RUNNING ACTION

The drawer frame has an exceptionally smooth running action. The opening and closing noise is virtually imperceptible. The synchronous guidance guarantees absolutely even and seamless motion of the drawer runners.

## 41 SYSTEM LOAD CAPACITY

- up to 40 kg, for 600 mm width
- up to 60 kg, for 800 mm and 900 mm width

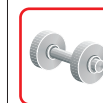

- up to 70 kg, for 1000 mm width
- up to 80 kg, for 1200 mm width



## 42 SIMPLE ASSEMBLY AND ADJUSTMENT

The panels can be assembled and removed without tools, one-dimensionally and in a single motion: The panel is simply clipped on. A audible "click" confirms that the



drawer front is firmly in place.

## 43 JOINT PATTERN

The front panels can be adjusted quickly and easily. The front panel adjustment is simple to carry out, with instructions for vertical and horizontal movement clearly shown on the units themselves.

## 44 GUIDES WITH PRISM PRINCIPLE

Drawer guides with unique prism principle. The prism principle guarantees an optimally aligned motion sequence and ensures high side stability as well as low sag rates.

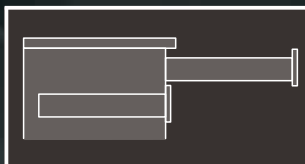

## 45 HIGH-QUALITY DESIGN

The Profi+ frame shape conveys quality, durability and remarkable stability. The pull-outs are equipped with a rounded railing as standard.

Enclosed side panelling is available in steel or glass sides as shown below for a small surcharge. For internal drawers with steel or glass sides, the front panel is supplied standard in a glass design.



## 47 INNOVATIVE CUSHIONING SYSTEM

Super comfort with silent closure. The newly developed standard cushioning system ensures a smooth closing movement every time. In the last stage of the closing process, the movement slows down similar to a slow-motion effect and closes silently.

The adaptive cushioning is effective for both empty as well as fully loaded drawers. Drawers open virtually effortlessly for comfortable and simple use, even with handleless fronts.

## 48 EASY-TO-CLEAN

Particularly easy-to-clean due to flush-surface integrated soft edges in the drawers.

## 49 ASSEMBLY WITHOUT TOOLS

Due to the quick assembly and removal, Profi+ drawers are very fitter-friendly, easy to clean and suitable for relocating.



## 50 OPENING SUPPORT MECHANISM

Electromechanical or sensor operated systems facilitate the opening of pull-outs. For instance, a slight touch of the knee to the waste collector is sufficient to open the pull-out. Thus, there is no need to touch the door with full or dirty hands.

## 46 HIGH-QUALITY WORKMANSHIP

Profi+ inspires with its high-quality workmanship. The connections between front panel, rear panel and frame as well as that between drawer and guides are sturdy and secure.

With the new Profi+ drawer system, nobilia introduces an innovative product highlight of the highest technical level which once again raises the bar in the kitchen market. The Profi+ system, which received multiple awards, impresses with its superior smooth running action, exceptional stability, high-quality design and added storage space. Moreover, Profi+ scores with its simple assembly and easy adjustment. nobilia exclusively fits all its kitchens with this innovative drawer system as standard.



# WHAT TYPE OF WOOD IS MY KITCHEN MADE FROM?

## 51 CARCASE DÉCORS – CLEANLINESS FIRST

- Interior carcase colour: standard = White.
- Bright interior: good overview, everything is easier to find.
- End customers connect White with factors such as hygiene, cleanliness, health.
- Carcase colour exterior: In your choice of 17 trendy carcase colours
- Glass wall units or shelves are available in carcase décor on both faces (interior as well as

- exterior) without a surcharge. Thus, there is no visible side specification necessary.
- No surcharge for exterior décors. And with a later relocation, all units can be repositioned.
- Information regarding care of carcase and fronts can be found at: [www.nobilia.de/en/service/instructions/care-instructions](http://www.nobilia.de/en/service/instructions/care-instructions)

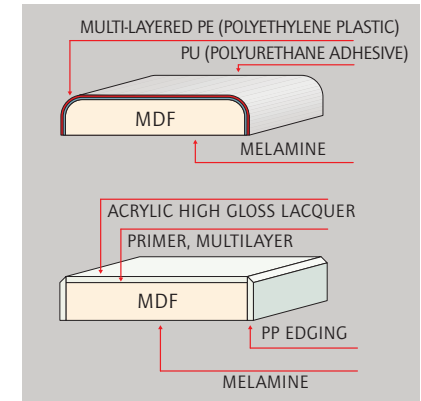
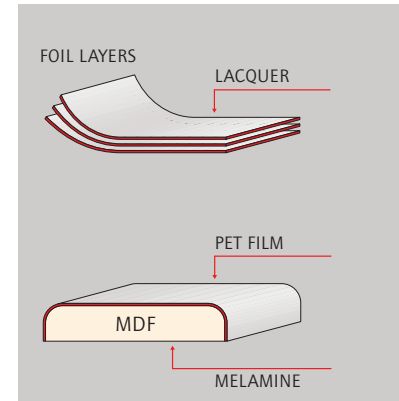
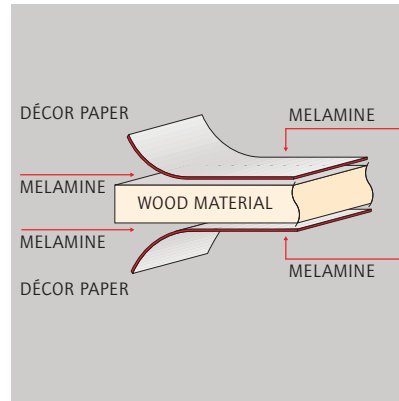
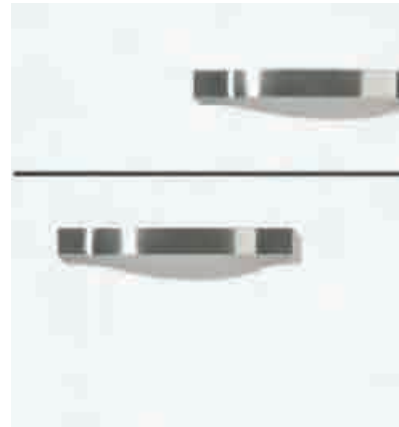

## 52 MELAMINE DIRECT COATED

- Optimal for kitchen furniture
- Extremely resilient
- Surfaces could contain fine textures which only enhance the beautiful wood reproduction appearance.
- Easy-care
- Affordable



## 53 LACQUERED LAMINATED FRONTS

- Lacquered PET film
- High gloss or softmatt version
- Smooth front vertically seamless
- In the framed version rounded on all sides and without seams
- Attractive alternative for genuine lacquer fronts
- Outstanding value for money

## 54 LACQUER FRONTS

- Pure material appeal
- Hard-wearing, easy to clean
- Seamless front faces in honed lacquer and high gloss lacquer
- Fronts in ultra high gloss with PP edging on all sides
- Honed lacquer with slight texture, for better scratch-resistance

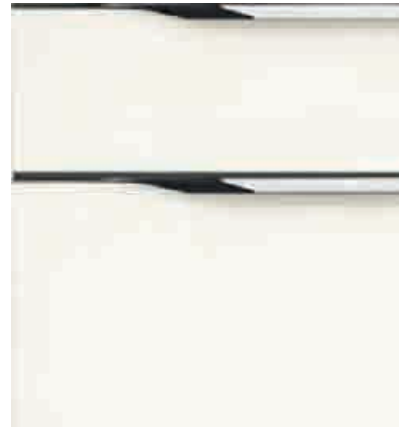

## QUALITY FOR ALL PRICE GROUPS

State-of-the-art processing technologies and the highest quality materials speak in favour of the entire spectrum of nobilia fronts and carcasses. Here, we will show you the characteristics and advantages of the selected materials.

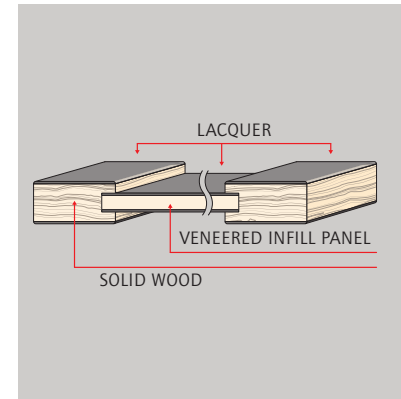
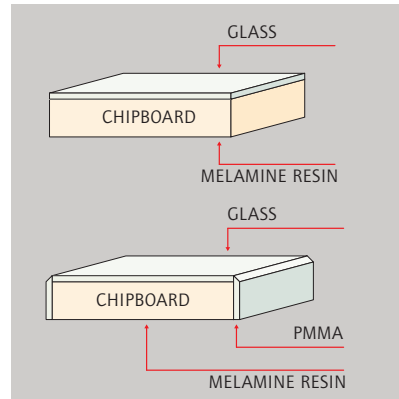
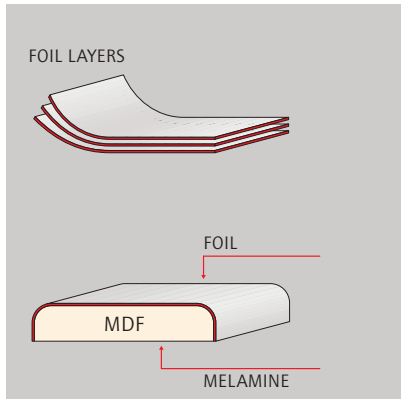
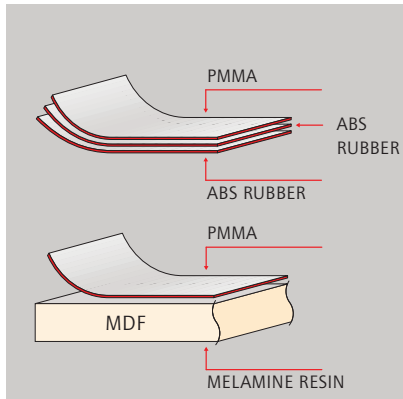

### 55 ACRYLIC FRONTS

- Shine and depth of gloss unequalled in glass reproduction
- The look of real glass, only lighter and more affordable
- Ample strength, shatter-proof
- Unrivalled for metallic effects
- Easy care - scratches can be treated with polish (POLI, order no. 4983).

### 56 FOIL-COATED FRONT

- Seamless rounding on all sides possible
- Extremely resilient
- Also ideal as a framed front, seamless front face
- An attractive alternative to genuine wood or lacquer
- Outstanding value for money

### 57 GLASS FRONTS

- Exquisite degree of shine, for a look that is unsurpassed
- Optimal for kitchen furniture
- Resistant, easy to clean
- Upper price segment

### 58 GENUINE WOOD FRONTS

- Genuine wood framed door with veneer infill panel, lacquered
- Panel made of solid wood, lacquered
- Due to the lacquer coating the surface is hard-wearing and easy to clean
- Upper price structure

## OUR WORKTOP IS THE TOUGHEST!



nobilia worktops are distinguished by outstanding functional value.

- The substrate of the 38 mm thick worktop is high quality 3-layer chip board.
- They are coated with hard-wearing plastic laminate panels (HPL high pressure laminate and CPL continuously pressed laminate surfaces).
- The thickness of the laminate measures 0.6 to 0.8 mm.
- Lateral cut edges are provided with décor edging.
- Usable depth: Standard 600 mm up to max. 1170 mm, 1200 mm for N edge
- Butted glued joints are ensured with waterproof D3 glue (PVAC - polyvinyl acetate glue).

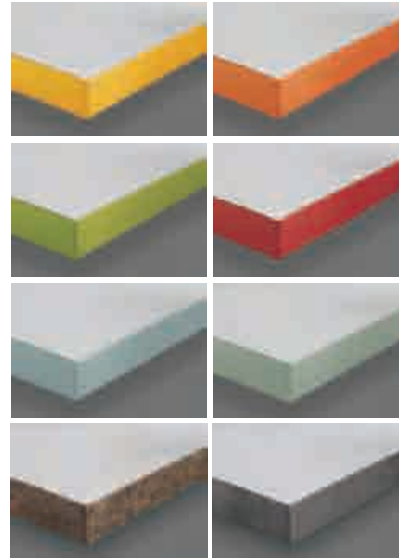

### 59 N EDGE

The panel is laminated around the rounded front edges. The sides can be finished with 1.5 mm thick décor edging or inset N edge (for a surcharge). For optimum protection against moisture the N edge is sealed over the transition to the bottom face.

### 60 DÉCOR EDGE

Décor edges are 1.5 mm thick PP plastic edging, available in all worktop décors and 8 COLOR CONCEPT colours. The PP edging is glued with waterproof PUR adhesive.

PP front edges enable individualised freeform surfaces for worktops, tables and breakfast bar attachments.

### 61 THE SURFACE: SUPER TOUGH!

Worktop surfaces demonstrate a high degree of resistance to scratching and abrasion in accordance with DIN standard 68930. This is to ensure that the worktops can withstand the wear associated with conventional household use.

### 62 WELL PROTECTED: AGAINST MOISTURE AND HEAT!

The bottom face of the worktop is surfaced with a water repellent, resin impregnated paper and has a moisture protection seal along the rear edge. Heat resistant up to 180°C with dry heat and up to 100°C with moist heat (DIN 68930).





16 MM



25 MM



50 MM

**63** WORKTOP  
SLIM LINE 16 MM

Slim Line worktops have a high quality laminate coating on both faces. Greater practical utility due to HPL and CPL surfaces. Décor edges all around in 1.2 mm.

**64** UPRIGHT PANEL SYSTEMS: 98 DÉCORS IN 3 MATERIAL THICKNESSES AND 8 DESIGNS

nobilia upright panel systems are available in 98 décors and widths of 16 mm, 25 mm and 50 mm. The available range of units is dependent upon the material thickness: upright panels, wall shelves, cover panels, plinth and cornice shelves.

# CUSTOM KITCHENS – WITH DIMENSION® BY NOBILIA

**dimension®** creates the perfect blend to meet the various individual needs for organisation, storage, ergonomics and design. Design-oriented kitchen design

combined with the respective optimum heights for the main work stations involved in daily kitchen activities – formally and ergonomically perfect!

**dimension®** stands for more “capacity”, more leeway in planning and even more planning security.

## 65 24 ACTIVITY HEIGHTS

The nobilia **dimension®** grid systems offer design-oriented kitchen planning while incorporating correct activity heights by combining a total of 24 different working heights. With three base unit heights, four plinth heights and two worktop heights, a variety of 24 different activity heights can be achieved, which perfectly support the ergonomic requirements of today's kitchen users for the various activity zones in the kitchen. The right dimension for every task.

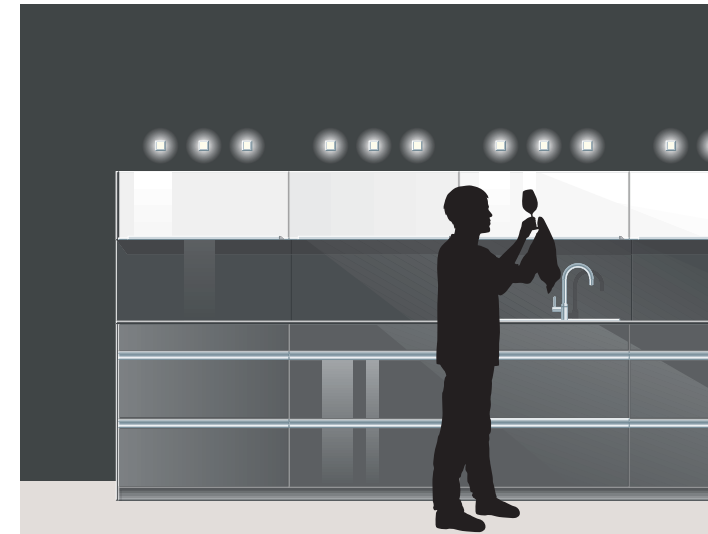
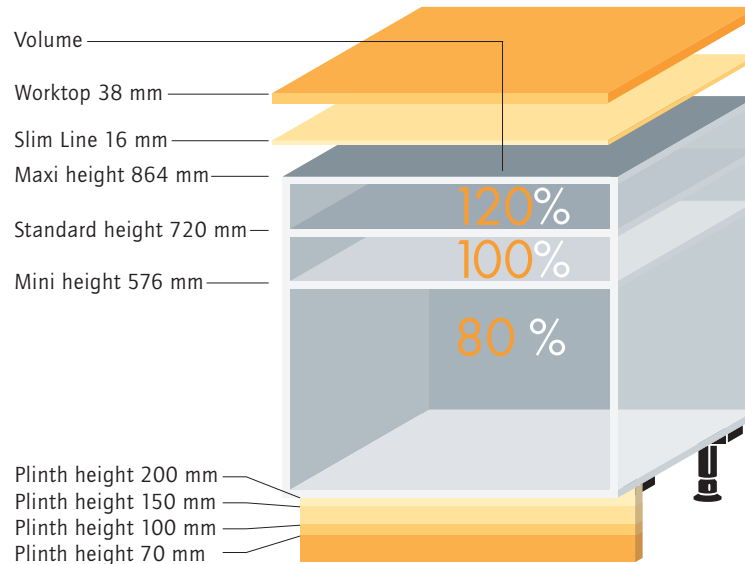

## 66 3 BASE UNIT HEIGHTS

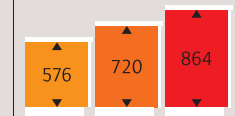

All measurements are in mm.



67 4 PLINTH HEIGHTS

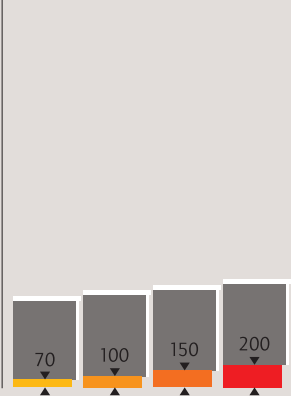

68 2 WORKTOP HEIGHTS

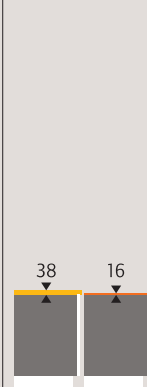

69 5 WALL UNIT HEIGHTS

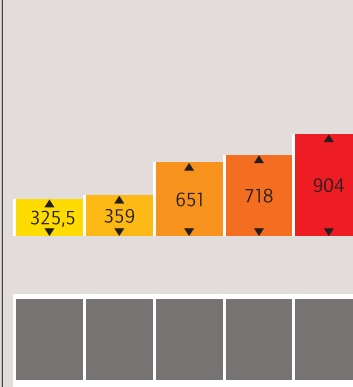

70 4 DRESSER UNIT HEIGHTS

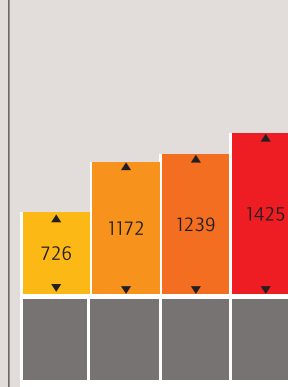

71 4 TALL UNIT HEIGHTS

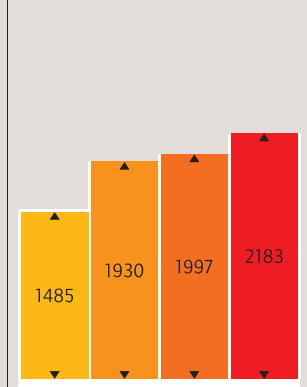

## SYSTEM GRID

### 72 THE MODERN FOUR DRAWER GRID

Here, the base standard height is divided into a maximum of four 177 mm high drawers. The pull-outs are 357 mm high, continuous doors are 717 mm high. The 72 front design is based on the 717 mm door height and supports straightforward modernity as well as emphasises international contours in the kitchen.



### 73 THE CLASSIC FIVE DRAWER GRID

Here, the base standard height is divided into a maximum of five 141 mm high drawers. The pull-outs are 285 mm high, doors are 573 mm high and pinned with a panel, or positioned beneath a drawer. The 57 front design is based on the 573 mm door height and is predominantly used for the choicest classic front designs.



### 74 MODERN FOUR DRAWER GRID WITH MAXI HEIGHT

Also when combining different activity heights, the front designs in 4 and 5 grid remain in place.

Maxi height in conjunction with standard heights in 4 grid is particularly well-suited for raised sinks and preparatory kitchen work areas.



### 75 CLASSIC FIVE DRAWER GRID WITH MINI HEIGHT

Mini height in combination with standard heights in the 5 grid. An ideal solution for lowered hot plates.



An ergonomically well-planned kitchen always meets personalised needs. It is the perfect adjustment of the kitchen architecture and kitchen organisation to people and their work flows.

Here are several points which should be taken into consideration:

- The ergonomically correct working height for the individual tasks in the kitchen is essential to ensure healthy and relaxed kitchen activities.
- In order to take the stress off the spine it is also important to alternate postures. This means, in addition to standing workspaces, a seating area for preparatory work should also be incorporated.
- Electrical appliances should be planned at heights comfortable

for viewing as well as reaching.

- Plan on including base units with full pull-outs as these offer plenty of clearly arranged storage space and are easily accessible.
- Electric opening support mechanisms and silent closure cushioning on base units provide additional convenience.
- Wall units with flaps, folding/lifting doors or swivel flap doors make opening and closing easier and also provide headroom.
- For angled kitchens, it is preferable to plan corner units for optimum use of storage space.
- Good lighting is indispensable in the kitchen. Whether it be in the niche with a good task light, in base and wall units or in the dining area.

ERGONOMICALLY CORRECT KITCHEN DESIGNS

When deciding upon the proper working height for the individual kitchen activities, it is not the height of the body which is decisive, but rather that of the elbow. With a modern measuring device such as the AMK Ergonometer the ergonomically correct working height can be determined precisely and quickly.



76 SINK IN MAXI HEIGHT

For a sink, the active surface is actually the base of the sink. This is why it should be planned at a height above the normal working height. Optimally, the sink bottom should reach 100 to 150 mm below elbow height. This relieves the pressure in the spinal discs.



77 PREPARATORY WORK AT STANDARD HEIGHT

The standard height of 720 mm used in this planning example is only intended for the preparatory work area. Depending upon the plinth height, this activity height corresponds to the normal posture of average size persons while performing preparatory activities in the kitchen.



78 HOT PLATE AT MINI HEIGHT

The actual activity height for cooking is the upper edge of an average height cooking pot/pot sitting on the hot plate. Optimally the carcass at mini height should fall approx. 250 mm below elbow height. This facilitates relaxed cooking since stress is taken off of shoulders and arms.



The U-shaped kitchen shown with attached island for preparatory work and with a dining area is planned such that only short walking distances are necessary in normal everyday kitchen use. This is demonstrated particularly well in the main kitchen run with hot plate, cooking preparation and sink areas. The raised electrical appliances and the plentiful storage space have also been sensibly grouped in terms of ergonomics and are thus easily accessible. Here, we introduce you to ergonomics with numerous sensible functions and details in a space of merely 16 m<sup>2</sup>.

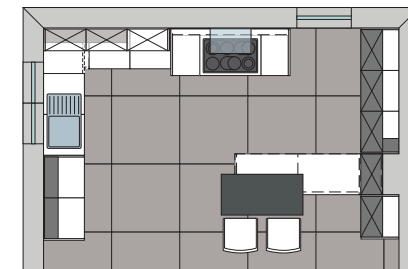

## 79 RAISED ELECTRICAL APPLIANCES

Electrical appliances at user-friendly heights make loading and unloading extremely convenient, ensure that kitchen activities are easier on the back and prevent back problems.

In addition to ovens, steam cookers, dishwashers or fridges, even microwaves and coffee machines can be integrated at ergonomically correct heights.

Thus, no valuable workspace on the worktop is wasted, and the everyday kitchen routine with all its activities is guaranteed to be relaxed.

## 80 PHARMACIST PULL-OUT

The larder unit, with cushioned opening and closing, glides quietly in and out of the carcass until the movement is gently damped. Everything is clearly arranged and can be accessed from both sides. The height of the baskets can be adjusted and upon request they can be equipped with side glass panels.



**82** HEADROOM

Wall units with flaps, folding/lifting doors or swivel flap doors offer a great overview of contents and are freely accessible, since no open doors are in the way. The new generation of cooker hoods also guarantees optimum headroom, even for taller people, due to the slanted extraction surface of the hood.



**83** STEPLADDER

A step ladder is indispensable when you want to reach the uppermost compartments of highboards and tall units. Folded up, the step ladder can be stowed away practically in a bottom full pull-out.



**84** OPENING SUPPORT MECHANISM LIBERO

With the sensor-operated opening support mechanism Libero for the waste separation systems Euro-Cargo Soft, Euro-Cargo S, Separato-K, Separato-M and Cargo frame the front pull-out can be easily opened with a simple foot movement via a sensor in the plinth area.

**81** FRONT PULL-OUTS

Front pull-outs offer the convenience of easy accessibility, optimum use of storage space and customisable organisation possibilities. You are spared the wearisome stooping that is necessary with hinged door units.

Special pull-out organisers can be found on page 29.



**85** OPENING SUPPORT MECHANISM SENSOMATIC

The electro-mechanical opening system Sensomatic for drawers and front pull-outs functions by lightly touching the front. As though moved by an invisible hand, the pull-outs open through an electro-mechanical mechanism on the rear of the carcass and thus make opening easier.



**86** ROLL-UP FRONT DRESSER UNIT WITH TRIPLE SOCKET

An electrical connection right where you need it - roll-up front dresser units have an integrated triple socket and offer convenient storage for mobile small kitchen appliances.

# THE HANDLE-LESS KITCHEN LINE N

Modern designer kitchens appear large with straight lines. High quality lacquer fronts or perfectly crafted matt fronts with seamless, laser-welded edges are best shown to advantage without handles. Handle-less fronts automatically create the impression of a linear and uniform appearance. It is no wonder, then, that handle-less kitchens have advanced to the ranks of new designer kitchens. Of course, handle-less kitchens are not really without handles. The ergonomically shaped recessed handles are perfectly positioned on the carcass to enable comfortable access to doors, drawers and pull-outs.

## Recessed handles: Design and Material

- The handle profile is anodised aluminium and is available in nine colours.
- End caps as well as inner and outer corners are made of plastic in a matching colour, lacquered in a stainless steel finish.
- Carcase side panels are routed and thus ready for mounting the recessed handles.
- Handle profiles are cut to size and ready for mounting, with straight cuts and mitre cuts for inner and outer corners.
- L profiles on base units can be optionally equipped with an LED lighted design for a surcharge.



2 BASE UNIT HEIGHTS  
360 mm | 720 mm



3 WALL UNIT HEIGHTS  
359 mm | 718 mm | 904 mm



3 TALL UNIT HEIGHTS WITH  
HORIZONTAL RECESSED HANDLE  
1485 mm | 1997 mm | 2183 mm



3 TALL UNIT HEIGHTS WITH  
VERTICAL RECESSED HANDLE  
1485 mm | 1997 mm | 2183 mm

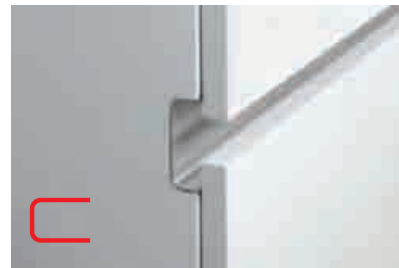

## 87 LINE N THE PRODUCT RANGE

- LINE N kitchens are available in seven ranges and 37 front designs.
- Wide price range from the introductory price level in price groups 2 to 4 and up to the high end price group 9.
- Extensive range of units with two base unit heights, three tall unit heights and three wall unit heights.

- No separate distribution line, but rather fully integrated into the nobilia range; clearly arranged in a separate chapter.
- The nobilia kitchen block pricing method also applies to LINE N kitchens.

## 88 RECESSED HANDLES L AND C PROFILE

- As a rule, L profiles are used beneath the worktop on base units and beneath the top shelf on highboards.
- The recessed handle with C profile is used between the fronts on base and tall units.

## 89 RECESSED HANDLES HORIZONTAL

- The maximum profile length for horizontal recessed handles is 4000 mm.
- The horizontal handle profile as well as the required mounting materials, 90° corners and end caps are included in the unit price.

## 90 RECESSED HANDLES VERTICAL

- Vertical recessed handles are supplied in suitable lengths for highboards and tall units.
- Vertical recessed handles are individually planned and invoiced. These are not included in the unit prices.





**94** TRANSITIONS  
HORIZONTAL

When planning with horizontal recessed handles, the aim is to achieve a continuous visual line from base units to directly adjacent tall units. A hairline gap is formed in the profile at the transition between the L profile of the base unit and the C profile of the tall unit.



**95** PLANNED END OF RUN  
WITH FRONT UPRIGHTS

With front-finish upright panels, it is possible to have the handle recess run straight through the panel. Front-finish uprights are available finished on the rear as well as the front, for designs with islands. Front-finish upright panels are available in all Line N front finishes.

**91** ROUTERED OPENINGS

Milled openings are used on connections to walls, front fillers, end uprights, front end uprights and continuous profiles for the transition from C to L profiles.



**96** PLANNED END OF RUN  
WITH END UPRIGHTS

End uprights are available in all décor groups in a depth of 597 mm for a front line that is flush with uprights. If the end of run is planned with a front upright or end upright, the last carcass side is routed through and the recessed handle ends at the upright.

**92** ROUTERED POCKETS

Routed pockets occur at open ends of runs, but also in conjunction with a C profile at transitions to dishwashers or built-under fridges and freezers. Carcase sides are routed by 8 mm.



**97** PLANNED END OF RUN  
WITH COVER PROFILE NADP

For a price-oriented solution without uprights, a cover profile NADP is available in a stainless steel finish. This clads the planning distance of 15 mm to the wall. The visible carcass side comes standard with a pocket routed opening.



**93** PROFILE END CAPS

The profile end caps are supplied with routed pockets as well as routed openings for assembly on site.



**98** RECESSED  
HANDLE LIGHTING

It is possible to add LED lighting to the top handle recess of our Line N Base units, for a surcharge (MP-NGML). Lighting can be planned individually, allowing us to only have the LED lighting where our customers want it.

# DISTINCTIVE PLANNING FEATURES LINE N

## Planning with dishwashers

- Only fully integrated dishwashers can be planned.
- A minimum plinth height of 150 mm is required for planning dishwashers.
- Include an end upright when planning a dishwasher at the end of run.

## 99 TALL UNITS – HORIZONTAL RECESSED HANDLE

Recessed handles are especially suited for combinations of tall and base units. This achieves a uniform visual line.



## 100 DISHWASHER – APPLIANCE HEIGHT 810 – 820 MM

They are mounted beneath the recessed handle (L profile). Adjacent base or tall units with C profiles will be provided with a milled pocket. In addition to the end upright, a special front upright is available for planning dishwashers at the end of a run.



## 101 DISHWASHER – APPLIANCE HEIGHT 860 MM

Large-capacity dishwashers with an appliance height of 860 mm will be planned with a spacer frame with integrated recessed handle. The recessed handle is milled all the way through and ends with the carcass exterior of the adjacent units. Between the dishwasher and the adjacent base units there is a 3 mm hairline gap.



## 102 PLANNING WITH INDUCTION HOT PLATE

L profiles beneath induction hot plates can be milled in three lengths: 550, 750, 850 mm. The milling depth is 5 mm. The necessary width is determined based upon the ordered hot plate.



Milling is not necessary for appliances from the BSH group and Electrolux hot plates in conjunction with the PBOX\*.

**103** ALL UNITS ARE PLANNED 15 MM FROM THE WALL

- As a rule, various built-in appliances must protrude by 15 mm when planned with 600 mm deep worktops or top shelves.
- Spacers for mounting are

- included in the scope of delivery.
- Example:  
580 mm = Base unit footprint  
+ 15 mm Distance to wall  
= 595 mm Planning dimensions
- Overhang of worktop, at the front 3 mm, at the side 1.5 mm

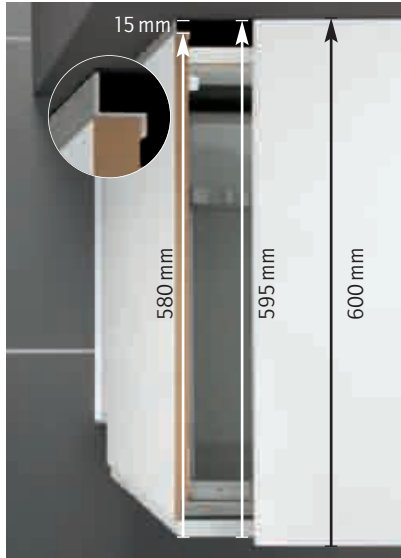

**104** HANDLE PROFILE FOR WALL UNITS

- LINE N wall units are available in heights 359 mm, 718 mm and 904 mm.
- The wall units have a profile strip attached to the wall unit bottom shelf.

- The handle profile is visually identical to the MP-WOG from the standard range. Handle-less wall units can thus be combined with the LINE N range.



**105** TALL UNITS - VERTICAL RECESSED HANDLE

Vertical recessed handles are particularly suited to the convenient opening of the large-size doors. Intermediate and end of run recessed handles (25 mm planning width) are individually planned and invoiced. An end upright is always required for the planned end of run and for adjacent base units.

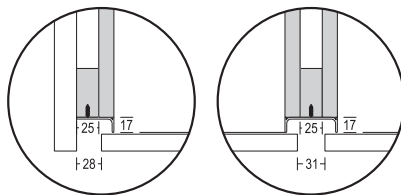

End of run recessed handle      Intermediate recessed handle

**106** CORNER SOLUTIONS WITH FILLERS

Angle fillers are mitre cut at the factory. The planning dimensions must be specified with the order. Adjustments on site are not possible. A shortened carcass blank panel for affixing to adjacent units is included in the scope of delivery.

**107** INTEGRATED LIGHTING FOR WALL UNITS

For a surcharge, the integrated lighting designs NOVA PLUS and MANILA PLUS can also be integrated into the top or bottom shelf of the wall unit. For a surcharge, a profile strip with LED lighting or a lighted bottom shelf are available.



## DRAWER ORGANISERS



### 108 CUTLERY TRAYS

A large selection of cutlery trays made of plastic or wood provides the very best drawer organisation.

Fits all drawer widths from 300 mm to 1200 mm with 561 mm side depth.

Several cutlery trays are available for a side depth of 461 mm.

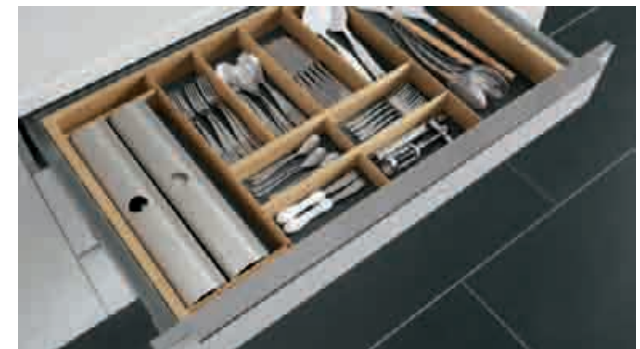

Versatile organiser systems for drawers and pull-outs offer structured storage for everything you want to accommodate in the kitchen. From cutlery, cling film and spices to baking trays and even entire beverage crates. Variable designs, easy-care plastic, sophisticated solid wood or a combination of both. With fixed or variable division possibilities – the perfect solution for every need!



109 FULL PULL-OUT/  
UNIVERSAL ORGANISER

- Made of beech, oak, black ash or silver-grey plastic
- Lets the customer decide where to place the solid wood or plastic dividers to suit his or her own kitchen requirements.
- Unit widths: 600, 800, 900, 1000 and 1200 mm

- Full pull-out load capacity up to 40 kg, for 600 mm width, up to 60 kg, for 800/900 mm width, up to 70 kg, for 1000 mm width and up to 80 kg for 1200 mm width.



## THIS CALLS FOR ORDER!

### 110 FULL PULL-OUT 150 MM TOWEL RAIL

Only 150 mm wide, but very practical: Base unit pull-outs with towel rails.



### 111 FULL PULL-OUT 150 MM 2 METAL BASKETS

In a narrow space of just 150 mm, next to the cooker or hot plate, for instance, everything you need is at hand.

Perfect for storing oil and vinegar or spices.



■ Load capacity per shelf 6 kg



### 112 FULL PULL-OUT 150 MM BAKING TRAY HOLDER

Finally, a clever solution for storing those countless baking trays and grids.



### 113 FULL PULL-OUT 300 MM INTERNAL PULL-OUT

An interesting solution that won't interrupt the lines of your kitchen. It looks like a door, but provides ingenious and ergonomic organisation possibilities.

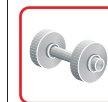

■ Load capacity per shelf 30 kg

We can offer our customers practical solutions specifically designed for their individual needs, especially in the area of pull-out organisation.

Sabine Trossehl,  
Interior designer in the Creative Studio



**114** FULL PULL-OUT 300 MM RECYCLABLES COLLECTOR

Pull-out unit with recyclables collector and lid for 40 litre recycling sack. Due to the narrow design of only 300 mm, the pull-out unit can be integrated practically anywhere.

**115** LARDER PULL-OUT JUNIOR 300 MM

With its width of 300 mm, the larder pull-out Junior requires little space and offers a high degree of convenience with access to stored items from both sides. Shown here is the variant with the organiser system UBOXX with an adjustable division for knives and cutting board holder.

**116** LARGE CAPACITY PULL-OUT

The large capacity pull-out in widths of 800, 900 and 1000 mm maximises the storage space by making use of the otherwise empty space in the plinth area. This opens up enough space to store even beverage crates. And that reduces the number of trips to the cellar!

**117** CARGO PLINTH

Just like the large capacity pull-out, the Cargo plinth also makes use of the empty space in the plinth area for maximum storage. This leaves enough room for a "full scale" waste separation system in a minimum of space.



## INDIVIDUALISED COMFORT

For kitchens with diverse floor plans, from the small to the very large, the nobilia kitchen system helps you find the right answers for effectively planning your kitchen space.

For instance, optimising storage space with the plinth drawer and additional internal drawers, the concealed pull-out table in the base unit or the shapely Z solution for end of run units when space starts to get tight in the kitchen.



### 118 OPEN FRIDGES WITHOUT HANDLES

The electromechanical opening system EASYS enables easy opening of fridges with slight pressure, even in handleless kitchens. The door opens wide enough, so that it can be opened the rest of the way by hand. If the door isn't opened, it simply closes again on its own.



### 119 END OF RUN UNIT Z SHAPE

For a gentle transition into the room's free space or for better access to adjacent doors, the Z-shaped end of run unit is ideal. Not to mention that the perfect Z shape also creates an optimum seamless appearance.



### 120 APPLIANCES ALL-PURPOSE SLICER

The accessories range offers an electric all-purpose slicer for drawer widths starting at 500 mm. The all-purpose slicer can simply be folded away into the drawer for space-saving storage.

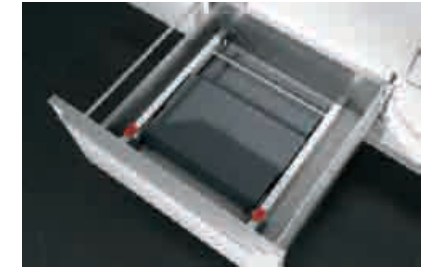

### 121 FOLD-OUT STEPLADDER

The aluminium fold-out stepladder can easily be stored in a drawer, a pull-out or hung on an integrated universal holder. For installation in base and tall units.



## 122 ORGANISING SYSTEM PANTRY BOX

The pantry box offers practical storage and fresh-keeping of fruit, vegetables, baked goods and other foodstuffs. The basis is a rigid plastic box that can be easily wiped clean.



A plastic bottom is inserted which has drain and ventilation slots to ensure ideal storage conditions. A tempered glass sliding lid guarantees that foodstuffs are hygienically covered while remaining visible. For installation in 600 mm wide pull-outs.



## 123 PLINTH DRAWER

The remarkably practical plinth drawer maximises storage space by utilising the "dead space" beneath the plinth. It is available in the widths 400, 450, 500, 600, 800, 900, 1000 mm and 1200 mm.



## 124 INTERNAL DRAWERS

Additional internal drawers can be planned for front pull-out and hinged door units. The internal drawer behind front pull-outs opens automatically using a latch for simultaneous opening.

Many units from the wide range of products are already equipped with internal pull-outs as standard. They can also be retrofitted at a later date.



## 125 PULL-OUT TABLE

The base unit with pull-out table provides a space-saving solution ideal for small kitchens.

- Available widths: 500, 600 und 900 mm
- Table heights (with plinth height 150 mm): 685 mm, 825 mm
- Max. load capacity: 30 kg

## THERE IS SPACE IN EVEN THE SMALLEST CORNER

With nobilia corner units you have absolute planning security thanks to alternative dimensions, customised comfort options and super storage space access.

- Planning dimensions for corners without storage space: 650x650 mm (angle filler for "dead corner")
  - Planning dimensions for corner units: 800x800 mm, 900x900 mm
  - Planning dimensions for diagonal corner units: 800x800 mm, 900x900 mm
  - Planning dimensions for half corner base units:
    - 650 (630) - 750 mm x 1050 (1030) - 1150 mm
    - 650 (630) - 750 mm x 1100 (1080) - 1200 mm
    - 650 (630) - 750 mm x 1150 (1130) - 1250 mm
    - 650 (630) - 750 mm x 1250 (1230) - 1350 mm
- Planning dimension changes from minus 20 mm to plus 100 mm are possible at the factory.



### 126 ANGLE FILLER UPE\* "UNUSED CORNERS"

- Affordable
- The corner solution with an angle filler offers no storage space.



### 127 CORNER BASE UNIT U(D)TE\* WITH SHELVES

- Price-oriented storage solution
- Easy access due to 165° hinge
- Can be disassembled on site
- Load capacity per shelf up to 50 kg/m<sup>2</sup>



### 128 CORNER WALL UNIT WE\* WITH SHELVES

- Easy access due to 165° hinge
- Maximum load capacity 75 kg
- Load capacity per shelf 16 kg
- Optimum design continuity with the corner base unit

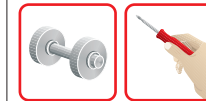

### 129 CAROUSEL UNITS UE(D)K\*/UE(D)T\*, 360°

- Mid-priced segment
- Intermediate level operating comfort
- Clear overview thanks to height-adjustable rotary shelves
- Can be disassembled on site
- 3D Front adjustment
- Adjustable closing force
- Load capacity per shelf: 25 kg

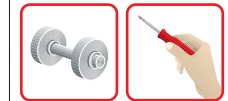



### 130 DIAGONAL CORNER UNIT UE(D)\*

- Diagonal corner solution with shelves
- Price-oriented storage solution
- Can be disassembled on site
- Load capacity per shelf up to 50 kg/m<sup>2</sup>



### 131 DIAGONAL CAROUSEL UNIT UE(D)T\*

- Rotary carousel with wooden shelves and metal railing offers a clear overview of contents.
- Mid-priced segment
- Storage space solution with intermediate level operating comfort
- Rotates 360°



- Can be disassembled on site

### 132 HALF CORNER UNIT UE(D)\*

- Diagonal corner solution with shelves
- Price-oriented storage solution
- Load capacity per shelf up to 50 kg/m<sup>2</sup>



### 133 HALF CORNER UNIT UEBD\* WOODEN SHELVES

- Mid-priced segment
- Half corner unit with wooden shelves and metal railing offers a clear overview of contents.
- Storage space solution with intermediate level operating comfort
- Load capacity per shelf: 15 kg

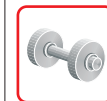

### 134 HALF CORNER UNIT UE(D)SA\* SWIVEL PULL-OUT

- High-end segment
- Swivel shelves open out into the kitchen, which make access to the back of the shelf so much easier.
- Excellent use of the unit interior. The shelf height is fully adjustable.
- Storage space solution with excellent operating comfort.

Part of the joy of cooking in an open concept kitchen is having a view of the living room to enjoy communicating with family or guests. Designing with downdraft extractor fans – extraction systems integrated into the hot plate – offers many practical advantages and is spot on the trend: They extract cooking steam and odours directly where it is produced, at the hot plate. They also provide maximum headroom above islands and thus plenty of room for individualised designs.

As a complete solution supplier, nobilia also offers an integrated solution from a single source along the lines of this trend: A private label selection of downdraft extractor fans and specially designed hot plate units for downdraft extractor fans in which vapours are cleanly conducted through the unit to the outside via a self-contained system – in your choice of circulating air or extraction mode. The furniture is tailored to the specific characteristics of the downdraft extractor fan and a closed air extraction system. The extracted vapours are not simply blown into the interior of the cabinet. Thus, moisture and mould growth don't stand a chance.

All downdraft extractor fans and respective hot plate units are perfectly prepared at the factory for installation. The recommended housing units fit the design of the downdraft extractor fans, insofar as there are special versions for fans with plinth motors as well as those located on top. The routing ducts for these appliances are housed in the plinth area. Dishwashers, plinth drawers or items with similar functions are not permitted in the area of the routing ducts.

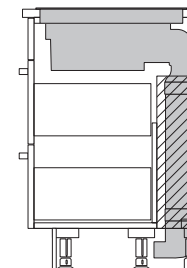

## 135 DOWNDRAFT EXTRACTOR FAN SEE YOU 90 IX

The SEE YOU downdraft extractor fan from Elica is a single appliance, which can be customised in combination with various hot plates. However, it cannot be combined with gas hot plates. The downdraft extractor fan is designed for the space behind the hot plate. For this reason, an additional 150 mm in depth must be planned, to fit the motor behind the base unit (worktop 750 mm deep). In order to ensure uniform extraction for all hot plates, we recommend combining with a cooking surface that has all the hot plates next to one another. SEE YOU is designed for both circulating air and extraction mode. For circulating air mode it is recommended that the air outlet be placed either on the side or at the rear.

- Circulating air mode: as of plinth height 70 mm
- Extraction mode: as of plinth height 150 mm



**136** CERAMIC GLASS HOT PLATE WITH INDUCTION AND DOWNDRAFT EXTRACTOR FAN SLIM B20

The SLIM B20 downdraft extractor fan from Airforce is designed for circulating air or extraction mode. The air is drawn in by the plinth motor. A special diffuser ensures that there is no noticeable draft with a front air outlet, since air guide plates deflect the air to the side. The metal grease filter and charcoal filter are accessible from above, thus simplifying any cleaning and maintenance work.

SLIM B20 can be installed in all hot plate units for downdraft extractor fans with plinth motor. LINE N kitchens require milling groove MP-NAUS1 for recessed handles.

- Circulating air mode: as of plinth height 100 mm
- Extraction mode: as of plinth height 150 mm

**137** CERAMIC GLASS HOT PLATE WITH INDUCTION AND DOWNDRAFT EXTRACTOR FAN NIKOLATESLA, A (EXTRACTION), F (CIRCULATING AIR)

The NikolaTesla downdraft extractor fan from Elica is available in versions for circulating air and extraction mode. The extraction element was positioned centrally. The appliance combination is equipped with sophisticated technical features, such as the double bridging function, or the automatic adaptation of the fan levels to the vapour development. The downdraft extractor fan is efficient and quiet, documented by the energy efficiency rating of A+. A ceramic filter – easily accessible from above – eliminates odours.

NikolaTesla can be installed in all hot plate units for downdraft extractor fans with motors on top. For circulating air mode it is recommended that the air outlet be placed either on the side or at the rear. LINE N kitchens require milling groove MP-NAUS1 for recessed handles.

- Circulating air mode: as of plinth height 70 mm
- Extraction mode: as of plinth height 150 mm

Maintenance and cleaning is simplified by the easily removable individual components such as grease filter and the four active charcoal filter which can be reactivated. These and the four active charcoal filters that can be easily accessible from above.

561 MM

522 MM



- Carcase depth for base and tall units: 561 mm
- Useable depth: 522 mm

Sensys hinges with Silent System cushioning, 3-dimensionally adjustable, maintenance-free, installation-friendly

Shelves, 16 mm  
All metal shelf supports with locking pin

Back panels, 2.8 mm HDF board in grooved sides, lacquered on both faces, screw-mounted to carcase

Construction shelf, 19 mm with side firmly affixed with dowels

Profi+ pull-out technology for crockery units, pantry units, appliance housings

## IT ALL FITS !

### 138 TALL UNIT WITH INTERNAL PULL-OUTS

- Easy, comfortable access
- Widths: 400, 500 and 600 mm
- Five internal pull-outs in all four tall unit heights



### 140 PANTRY UNIT CARGO

In the Cargo pantry unit the interior is linked to the door. When the door is opened, the shelves are automatically pulled forwards towards you, thus allowing easy access.

### 139 APPLIANCE AND PANTRY UNIT

- The universal unit in the truest sense of the word.
- With various internal divisions, pull-outs and drawers.



### 141 BROOM AND APPLIANCE UNIT

Everything you want, everything you need: System grids, cleaning materials baskets, system shelf units, peg board and hose holder for vacuum cleaner are preassembled.

## 142 LARDER UNIT

The larder unit equipped with SoftStoppPro cushioned opening and closing glides quietly in and out of the carcase until the movement is gently damped. The hanging baskets are available in two different designs:



- Hanging baskets with wooden shelf and metal railing
- Hanging basket with wooden shelf and glass side, for a surcharge
- Maximum load capacity is 80 kg



138

139

140

141

142

← 320 MM →  
← 300 MM →



## THE RIGHT SOLUTION FOR ALL WALLS

The wall unit mounting system guarantees secure mounting in honeycomb brick, sand-lime brick and concrete. Spacer panels are for compensating wall protrusions, for instance with tile, and are included in the scope of delivery. Freely suspended wall units can be provided with an anti-tip device on site to prevent lateral shifting. For maximum safety the anti-tip devices are automatically confirmed free of charge and are included in the scope of delivery.



- Carcase depth for base and tall units: 320 mm
- Useable depth: 300 mm

Shelves, 16 mm  
All metal shelf supports with locking pin

Sensys hinges with Silent System cushioning, 3-dimensionally adjustable, maintenance-free, installation-friendly

Back panels, 2.8 mm HDF board in grooved sides, lacquered on both faces, screw-mounted to carcase

Construction shelf, 16 mm with side firmly affixed with dowels



### 143 THE COMPLETE PACKAGE

The fixing rails for wall units come as standard. Upwards of 590 mm width requires 4 screws and dowels for maximum safety.



### 144 COVER CAPS STANDARD

Metal coloured cover caps come as standard with all wall units.



145 MAXIMUM LOAD CAPACITY

- Maximum load for wall units: 75 kg
- Load capacity per shelf 16 kg



146 DRESSER UNITS WITH ROLL-UP FRONTS

Roll-up front dresser units offer the advantage that small appliances are always at hand in the niche with socket and after use can be quickly stowed away again.

147 1200 MM WIDE WALL UNITS

Available in 325.5 and 359 mm height with flaps or in 651 and 718 mm height with folding/lifting doors.



- Available roll-up front colours: Stainless steel finish, as glass roll-up front in clear, matt or black glass
- Comes as standard with triple socket (dependent upon country) for roll-up front dresser units
- Possible with lighted design Manila Plus or Nova Plus for a surcharge

The extra wide wall unit comes as standard equipped with a Handle profile in the bottom shelf. This prevents sagging of the bottom shelf. The back panel has a centre hanger and a third wall unit mounting suspension.

An additional shelf support in the centre mounting suspension also prevents sagging of the shelves. Together these factors ensure better stability and safety. The wall unit load capacity is 75 kg.



# FLAP DOORS, BI-FOLD DOORS, SWIVEL FLAP DOORS, ROLL-UP DOORS!

The AVENTOS flap system brings more freedom of movement to wall units. Even large and heavy flaps move easily. Fittings from the AVENTOS series are used for wall units with flaps, folding/lifting doors and swivel flap doors as well as tall units with lifting doors and flaps. In keeping with the lasting trend toward electrification of the kitchen, folding/lifting doors and swivel flap doors can optionally be equipped with the Servo Drive electric motor operated opening system.

## 148 FLAPS

Flap door lifting fittings with 100° opening angle and integrated soft-close cushioning for wall units 325.5 mm and 359 mm high and for tall units.

The door remains in whatever position you want it.  
Unit widths:  
450, 500, 600, 800, 900, 1000, 1200 mm



## 149 BI-FOLD DOORS

For space-saving opening of wall units. The door remains in whatever position you want it. The closing force is individually adjustable, the hinge cushioned. Unit widths:  
500, 600, 800, 900, 1000, 1200 mm



## 150 SWIVEL FLAP DOORS

For space-saving swivelling of the front above the carcass. The hinge is cushioned. Unit widths:  
500, 600, 800, 900 mm



## 151 SERVO-DRIVE

Electric motor Servo Drive for wall units with swivel flap doors or folding/lifting doors. With Servo Drive, wall units can be opened with a simple light tap – and with a press of the switch integrated into the carcass side, comfortably closed again.



The alternative to hinged door units are roll-up front units and wall units with swivel flap doors, flap doors or folding doors. The advantages are clear: in a small kitchen, these reduce the opening angle of the doors and thus, stay out of the way. And headroom is also guaranteed with every unit. High-quality fittings technology guarantees that the flap doors stay put where you want them.



152 FOLDING-SLIDING DOORS

Works well in narrowly fitted kitchens, because the opening angle of the door is cut in half. The folding-sliding door functions via sliding technology on the top shelf. Only for 600 mm wide wall units.



153 CLIMBER WALL UNIT

The Climber wall unit with electric glass slatted front offers maximum convenience in three glass colours. The glass slats open and close automatically via touch control operation. Units widths: 500, 600, 800, 900, 1000 mm



154 WALL UNIT WITH iMOVE

iMove is an innovative storage system with a double tablar that is easy to use, ergonomic and can be lowered for better reachability of the stored goods, a clearer overview and quick access. Available as hinged door unit in 718 mm and 903 mm heights and as folding/lifting doors 718 mm high.



155 HANDLELESS WALL UNIT MP-WOG

Handleless designs are particularly suitable for unmistakably purist and design-orientated plans. For a surcharge MP-WOG, wall units can be equipped with a bottom shelf with attached profile strip in stainless steel appearance. This allows comfortable access, even with large swivel flap doors.

Alternatively also available with LED lighting, see point 158 MP-WOGL. Identical appearance to LINE N wall units. As a result, it is a master of combination. 1200 mm wide wall units with flap doors or folding/lifting doors come as standard equipped with MP-WOG at no surcharge.

Wall units can be custom upgraded with integrated lighting systems in the bottom and/or top shelf, as well as with additionally lit bottom panels. Not only does this provide a visual highlight, but, it also addresses an important topic in kitchen design: the efficient and consistent illumination of the individual work areas and activity zones.



**156** LIGHTING DESIGN  
MP-LA/MP-LAN

Wall unit bottom shelf of glass with integrated lighting. For wall units from 300 mm to 1200 mm wide. MP-LA/MP-LAN serves as unit interior lighting and as a recess light simultaneously.



**157** LIGHTING DESIGN  
MP-LED

Wall unit bottom shelf with integrated LED light strip. Available for 300 to 1200 mm wide wall units, minimum side depth of 180 mm. The full-length LED light strip provides uninterrupted illumination of the recess.



**158** LIGHTING DESIGN  
MP-WOGL/MP-LLIN

Wall unit bottom shelf with built in profile strip in stainless steel appearance and integrated LED light strip. Available for wall units 250 to 1200 mm wide with one or two doors, minimum side depth of 120 mm. The profile strip makes opening a handle-less wall unit design easy and comfortable. The full-length LED light strip provides uninterrupted illumination of the recess.



**159** LIGHTING DESIGN NOVA PLUS  
MP-LNP-O/MP-LNP-U

The integrated LED built-in light can be mounted in both the top and bottom shelves of wall units. For wall units and shelf units up to 1200 mm wide and with a minimum side depth of 180 mm. For optimum illumination, two lights are provided for widths exceeding 800 mm.



**160** LIGHTING DESIGN MANILA PLUS  
MP-LMP-O/MP-LMP-U

The integrated LED built-in light can be mounted in both the top and bottom shelves of wall units. Available for wall units, shelf units and plug-in wall shelves from 300 to 1200 mm wide. Depending upon the width of the unit, different widths of MANILA PLUS are used.

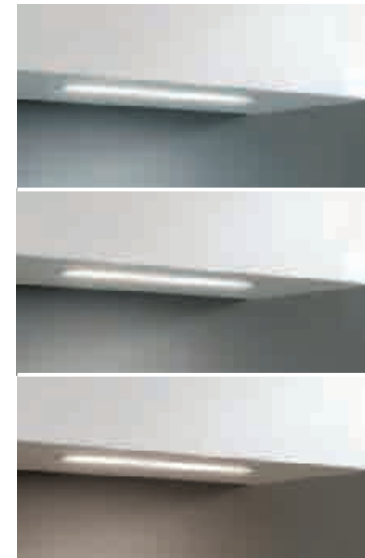

**161** EMOTION TECHNOLOGY

A large portion of the LED system is equipped with Emotion technology (s. Sales Manual, accessories, lighting chapter). With it the temperature of the warmth of the light can be infinitely adjusted from cold white to warm white (2700 - 6500 K). It is possible to coordinate with other sources of light in the kitchen.



**162** 4 CHANNEL LIGHT SCENARIO CONTROL

With the radio remote control you can control light scenarios in 4 different areas. Here, brightness as well as light colours can be regulated separately. With the "Gateway" module you can also control the functions through your in-house WLAN via your Smartphone or tablet.

## AMBIENT LIGHTING

Modern LED lighting technology has opened up a whole new world of possibilities for staging kitchens in the right light. Whether interior unit lighting, plinth lighting or lit open shelf elements – we have the right light for every purpose.



### 165 LED SHELF UNIT LIGHTING

Shelves for base units, wall units, highboards and tall units can optionally be outfitted with LED shelf unit lighting.



Shelf unit lighting is available for shelf widths of 150 - 600 mm and is standard equipped with Emotion technology.

The lighting can only be ordered for the entire shelf unit, and not for individual shelves. Invoiced per shelf.

### 163 LED LIGHT DESIGN FOR NICHE CLADDING

Niche claddings are optionally available with integrated LED lighting. The LED light strip is equipped with Emotion technology and ensures uniform and glare-free lighting of the work area.



### 166 LED INTERIOR UNIT LIGHTING FOR BASE UNITS

The LED interior unit lighting possesses an integrated sensor switch and is available in unit widths from 300 to 1200 mm. The LED power supply set ESS6-LED must be ordered separately.

### 164 GLASS SHELF WITH LED GLASS EDGE LIGHTING

The LED glass edge lighting creates the perfect union between furniture and lighting. Available for wall units in the widths: 450, 500, 600, 800, 900, 1000 and 1200 mm.



### 167 LED PLINTH LIGHT WITH GLASS COVER

The LED plinth lights can be custom positioned in the plinth. The drill hole diameter is 55 mm. Also available as LED plinth light set with 3 lights and starter set with Emotion dimmer.

Functional electrification in the kitchen is invaluable to ensure easily accessible electrical connections for kitchen appliances or charging connections for Smartphones and such. Whether custom positioned in the worktop, integrated in bar consoles or support legs or mounted in niches – there are countless possibilities for making the kitchen workday function smoothly.

168 | EVOLINE SQUARE 80

The EVOLine socket Square 80 is equipped with an USB charger. The sliding cover is designed as an inductive charging station for wireless charging of suitable smartphones.



169 | BUILT-IN SOCKET TWIST

The built-in socket Twist can be individually positioned in the worktop. The cover plate made of metal in stainless steel finish can be rotated to expose the socket.



170 | MULTIPLE SOCKET OUTLET WITH USB CHARGER

The multiple socket outlet with USB charger can be mounted anywhere in the worktop.



171 | INTEGRATED SOCKETS IN SUPPORT LEGS AND BAR CONSOLES

Stainless steel support legs and consoles for breakfast bars with integrated sockets bring even more functionality to the kitchen. Extremely practical for electrical connection of kitchen appliances, tablets, etc.



172 | EVOLINE V PORT

The retractable double socket EVOLine V Port has a USB charger and can be mounted in worktops and retracted.

173 | SOCKET TOKI

The double socket Toki is equipped with a USB charger for charging smartphones and tablets. The integrated speaker enables audio playback via Bluetooth.

174 | INTEGRATED USB CHARGER IN COOKER HOOD

The wall-mounted cooker hood Elica Bio has an integrated USB charger on the shelf made of solid oak.

## DESIGN POSSIBILITIES FOR SPECIALISTS

The interplay of colours, shapes and materials offer a broad field for inspiration and creativity, especially in the kitchen.

When it comes to targeted colour use in the kitchen, nobilia's COLOR CONCEPT provides extensive design freedom. Design using the modular system with open shelving, niche cladding, panel elements or sliding door units in modern single colour shades.

## COLOR CONCEPT



241 Maize Yellow



248 Fern



257 Sage



354 Concrete Slate Grey reproduction



249 Salsa



355 Ferro bronze décor

### 175 COLOR CONCEPT COLOUR SELECTION

Available COLOR CONCEPT colours: Maize yellow, Orange, Fern, Salsa, Aqua, Sage, Concrete slate grey reproduction and Ferro Bronze décor.

In addition, there are 17 carcass colours in other single shades and wood décors ready to be combined.

### 176 AVAILABLE RANGE OF UNITS

- Upright panels and top shelves 16 mm thick.
- Décor edges on worktops
- Shelf units, recessed shelves, wall units with sliding glass doors WSTG\* (325.5 mm and 359 mm high)
- Back panels on shelf units MP-DWR

- Niche claddings and panel walls (except PW180)
  - Shelf unit inserts WRLE / WRL-S
  - Flaps in wall unit height 359 mm
  - Folding/lifting doors and swivel flaps in wall unit height 718 mm
  - Cornice and light pelmets for Slim Line KLSL / LBSL
- The range of items is respectively identified in the product list.



254 Aqua



246 Orange





The design possibilities with shelf unit back panels are extremely versatile and variable. Whether with single colours, with colour accents from COLOR CONCEPT or with graphic motifs – the combination possibilities are virtually unlimited.

The panel wall sets are ideal for enhancing free wall spaces as well as niches. For exceptionally convenient planning, six basic sets are available for two niche heights, one highboard height and three tall unit heights. The panel elements can be individually equipped with wall shelves, glass shelves, shelf units, lighted shelves and the railing system.



## 177 CHANGING DÉCOR ON SHELF UNIT BACK PANELS

Shelf unit back panels are available in 25 shelf unit colours and optionally the standard same-coloured back panel can be designed as an accent.

11 alternative back panel décors are available: as a colour accent in the eight Color Concept colours or in the three graphic Vektor Art motifs.



## 178 SIMPLE PLANNING WITH PANEL WALL SETS

The panel wall sets have a mounted depth of 25 mm and are produced in widths between 250-2580 mm. All carcass colours and worktop décors are available as well as select high gloss décors. The grain of the textures is always horizontal.

In addition, panel wall sets are also available in stainless steel appearance. The profile system in stainless steel appearance lends the panel walls a perfect visual and functional framework. The panels can be individually equipped with wall shelf units, shelf units, TV holders



(suitable for screen sizes from 19" to 32"), lighting and railing systems. All elements can be unmounted with one simple movement and repositioned.

## NICHE CLADDINGS

The kitchen niche is often an under-appreciated space. Where simple tiles used to set the scene, today a wide variety of materials are used to make this area visually appealing and easy to clean. Moreover, there are diverse possibilities for organising the niche down to the last detail, for use as additional storage space with railing systems or shelf units.



### 179 NICHE CLADDINGS IN CARCASE, WORKTOP AND COLOR CONCEPT DÉCORS

- Coated on both faces
- 16 mm thick
- Horizontal texture
- Coated edging on all sides
- Width: 250-2580 mm
- Heights: 520, 700 mm

The niche cladding is available in the following designs: in carcase colours, COLOR CONCEPT colours, worktop décors, high gloss décors and in stainless steel appearance.

For a detailed overview, please refer to page M 2.1 in our Sales Manual.

- 2 fixed heights: 520 mm (niches beneath wall units), 700 mm (niches beneath cooker hoods)
- Custom dimensions according to sketch possible:  
W x H max. = 2580 x 2030 mm  
W x H min. = 250 x 250 mm

The maximum height for high gloss décors, stainless steel appearance and matt laminate coated décors is 1200 mm.

### 180 PLANNING BEHIND GAS HOT PLATES

Planning gas hot plates in conjunction with niche claddings requires a minimum spacing of 100 mm from the rear edge of the gas hot plate to the cladding.

Niche claddings with motifs are a stylish and practical idea for highlighting niches. 21 different digitally printed motifs are available to create targeted custom accents in the kitchen. You decide whether it will be typical kitchen motifs, flowers, or graphic Vector Art motifs.

Niche claddings made of glass are very exclusive and become an extravagant focal point. They are ideal for use as a spatter shield at the cooker or the sink, and can be cleaned effortlessly thanks to their easy-care surface.

## 181 GLASS NICHE CLADDING MADE OF ESG GLASS

- 16 mm thick: Substrate board 12 mm with 4 mm glass coating, rear face lacquered
- With PP edging on all sides, silver colour
- 4 fixed heights: 256, 437, 514 and 695 mm.

- 10 fixed widths:
- Available colours: Alpine white HG, Satin grey HG, Silver, White HG, Black HG, Glass appearance, Ivory HG, Sand HG, Savannah HG, Masterflow black matt



## 182 NICHE CLADDINGS WITH MOTIFS

- Imprinted with digitally printed motif
- For perfect colour harmony in the kitchen several motifs can have their basic colour matched to the carcass colours 088 Premium white, 106 White, 193 Alpine white, 120 Ivory, 070 Satin grey and 079 Savannah.

- In doing so, the colour will be matched to the lightest shade in the motif. For detailed information on this, please refer to chapter M 4.8 - M 4.10 in our Sales Manual.
- Information: The contact side of the motif is left, it is cut from the right. Minimum order dimensions: 250 mm

## 183 CUSTOM PLANNING

Glass niche claddings can be designed individually. In this case, made-to-measure dimensions are just as available as notching, profiling or drilling holes for sockets. Detailed sketches and a binding approval are required for the order.

- Subsequent processing of glass niches is not possible.
- Max. dimensions for glass niches with processing: height: 250 to 1200 mm, width: 250 to 2500 mm, Minimum price: 0.5 m<sup>2</sup>, Minimum dimensions: 250 x 250 mm Invoiced per m<sup>2</sup>.

## NICHE ACCESSORIES

Niche profiles create a clean transition to the worktop and the wall unit. They also ensure impermeability and thus prevent the ingress of dirt and water. Whether you choose a profile made of aluminium or plastic is purely a question of aesthetics.

### 184 RAILING SET

Practical sets with profile strip in three fixed widths: 600, 1200, 1800 mm. Comes equipped with the most important accessory items (paper roll holder, peg-board, multi-purpose shelf).

### 185 RAILING SYSTEM LINERO-MOSAIQ

The beautifully shaped railing system LINERO-MosaiQ in aluminium graphite black offers ideal storage possibilities for all kitchen utensils that need to be easily accessible.

Versatile storage solutions enable a clear overview and tidy organisation.



### 186 ALUMINIUM PROFILES NKPO AND NKPU

16 mm thick aluminium profiles for niche panels or back panels are supplied with a set of end caps. The profile thickness is 2 mm on the top and 4 mm on the bottom. The NKPU is supplied with a cover cap so that it can also be used as WAP.

### 187 PLASTIC COVER PROFILE NPUK

A translucent cover profile made of plastic is available to create a clean and discreet transition to the worktop. It is self-adhesive, extremely easy-to-assemble and 5000 mm long. The profile thickness is 1.6 mm.

### 188 CONNECTION PROFILE NPG

The connection profile NPG is used between two claddings planned above one another and thus enables individualised colour and material combinations. The profile ensures a clean seam, a secure and long-lasting connection and prevents penetration of dirt and moisture.

### 189 NICHE SHELF UNITS

- Height 519 mm with 2 shelves
- Height 257 mm with asymmetrical compartment divisions
- Side depth: 150 mm
- Widths: 500, 600, 800 and 900 mm.
- Available in all COLOR CONCEPT and carcass colours.

Units in special heights are available with three carcass heights: 288, 360 and 432 mm. In the basic variant, the cabinets are supplied without plinth feet or wall mounting. Thus, they are multi-functional and can be planned e.g., as attachment elements stacked on top of one another. For a surcharge the units are available in two equipment variations. These offer additional freedom of design for modern, design-oriented kitchen planning adjacent to the living area.



## 190 BASE UNIT IN FLOATING APPEARANCE MP-SUO

For a design with floating appearance, the base units are equipped with a heavy-duty mounting fitting and a support plinth for a surcharge. The units appear to float above the ground. Can be planned with special heights 360 and 432 mm.

The heavy-duty mounting fitting ensures secure mounting in honeycomb brick, sand-lime brick and concrete. Suspended mounting without support plinth is not permitted.



## 191 DESIGN WITH PLINTH MP-PSO

For a surcharge, base units in special heights are provided with plinth feet and a plinth panel for designs flush with the floor. These designs are particularly suited to residential solutions, e.g. as a bench seat, lowboard or TV bench.





The open shelf upright system integrates individual cosy accents in every kitchen. Whether as an individual shelf unit solution or directly integrated into the kitchen - the possibilities for designers/planners are virtually unlimited. The open shelf upright system is designed without a back panel and plinth for an elegant and floating appearance. The uprights and shelves of the open shelf unit are 25 mm thick, which allows them to be easily combined with the popular 25 mm thick upright system and wall shelf units. The open shelf upright unit is available in all 17 carcass colours.

#### HEIGHTS

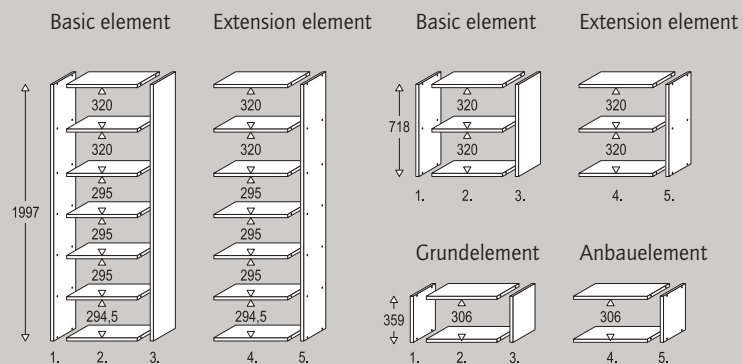

#### WIDTHS

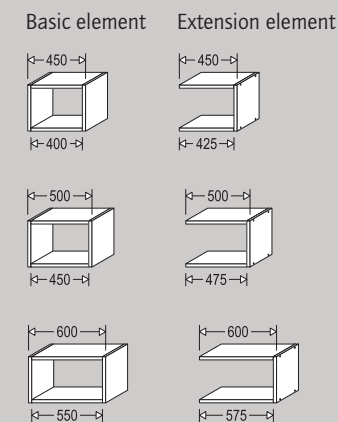

### 192 SYSTEM FOR WALL MOUNTING

- Conceptual design without back panel and plinth
- Only suitable for wall mounting
- It cannot be planned as a room divider.
- Height, width and depth reductions are not permitted.
- The load capacity per shelf is 50 kg/m<sup>2</sup>.
- For proper mounting, ensure a minimum space of 25 mm from the top to the ceiling or lintel.

### 193 THE WIDE RANGE OF POSSIBILITIES

- Available in 17 carcass colours.
- Available in three heights:
  - 359 mm, to match wall unit height of 359 mm
  - 718 mm, to match wall unit height 02
  - 1997 mm, to match tall unit height 02

- Available widths for basic and extension elements:
  - 450, 500 and 600 mm
  - depth: 341 mm

### 194 PLANNING WIDTHS

- The planning widths of the basic and extension elements are identical. For this reason, the shelf widths vary by the upright thickness of 25 mm. Planning open shelf upright units and units of the same width above one another results in a slightly asymmetrical look.

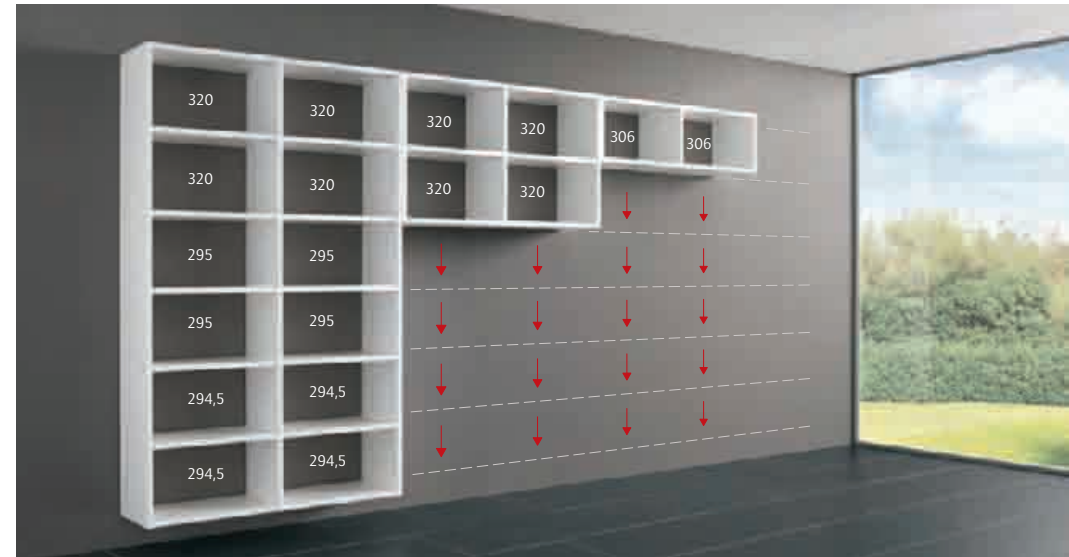
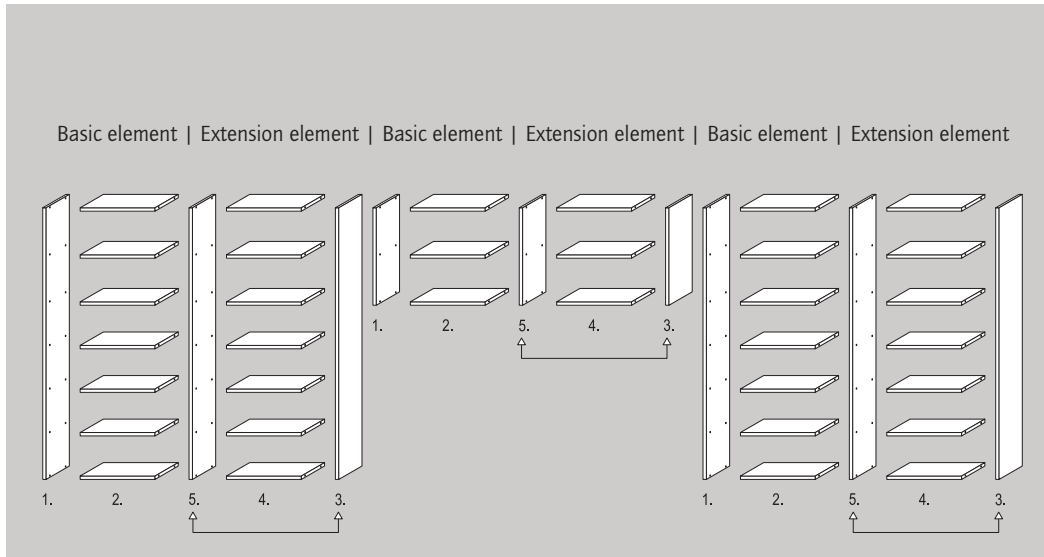

## 195 BASIC AND EXTENSION ELEMENTS

- Planning an open shelf upright unit always begins with the basic element.
- It is not possible to plan extension elements without a basic element of the same height.
- Basic elements can also be planned individually.

- A set comprised of basic and extension elements can only be ordered in the same colour.
- When combining basic and extension elements of the same height, one upright from the basic element (3) becomes the end upright on the last extension element.
- The side uprights of the basic element are not drilled on the outside face for a more polished appearance.

## 196 OPEN SHELF UNIT COMPARTMENT HEIGHTS

- In order to achieve a harmonious alignment when lining up open shelf unit elements of varying heights, take into consideration the different compartment heights.
- The compartment shelf division is fixed, a height adjustment of shelves is not possible.

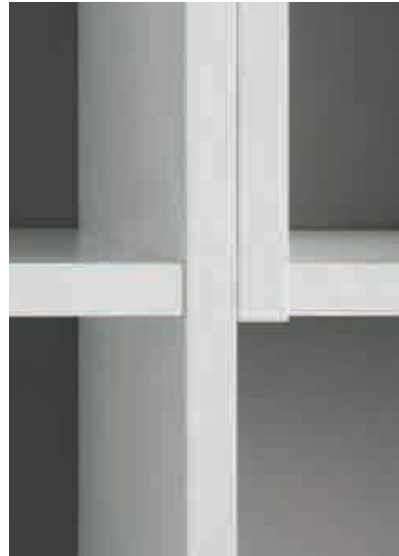

### 197 COMBINATIONS OF VARIOUS HEIGHTS

- When a single configuration combines open shelf upright units of different heights, the section with the new height must always begin with a basic element. It is planned upright to upright.



### 198 SIMPLE ASSEMBLY, CONVENIENT ADJUSTMENT

- Open shelf upright units are delivered disassembled and must be assembled on site.
- All uprights are pre-assembled with mounting and adjustment fittings.
- The heavy-duty mounting fitting ensures secure mounting in honeycomb brick, sand-lime brick and concrete.

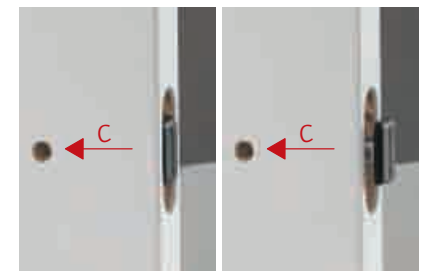
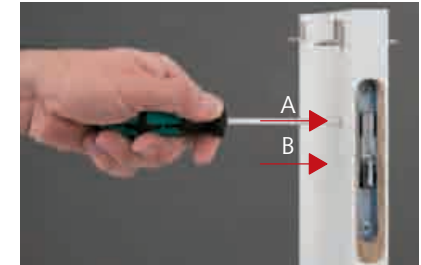

- Three-dimensional adjustment possibilities:  
 A Height adjustment: max. 18 mm  
 B Side adjustment: max. +/- 2 mm  
 C Depth adjustment: max. 9 mm





### 199 PLANNING IN GROUPS OF UNITS IN THE SAME WIDTHS

The widths of shelves for basic and extension elements vary by the upright width of 25 mm. Thus, planning open shelf upright units and units of the same width above one another creates a slightly asymmetrical look. The end of run side upright panel ensures the dimensional line is observed.



### 200 PLANNING IN GROUPS OF UNITS IN DIFFERING WIDTHS

To prevent a slightly asymmetrical look, it is recommended to combine different widths of open shelf upright units and units above one another.



### 201 PLANNING AS INDIVIDUAL SHELF UNIT

Open shelf upright units can also be used within a kitchen design in place of conventional shelf units made of carcass material. Thus, you will also find the open shelf upright units in the respective tall and wall unit chapters under open shelf units. The same planning criteria apply here as with the planning of entire walls of open shelf units.

**202** PACKING  
CARCASE COMPONENTS

Sides and front are completely covered with cardboard; Nylon belts (for strapping).



**207** HARD PLASTIC CORNERS

Hard plastic corners are used on the rear bottom carcass side of tall units for extra protection. This prevents damage due to standing on end.

**203** CORNER PROTECTION

Corner units are additionally equipped with a self-adhesive corner sleeve, to protect them from damage during transport.



**208** PACKING  
CORNER CAROUSEL UNITS

Corner carousel units have a cardboard cover with clearly defined gripping positions. This simplifies transport.

**204** PACKING  
WORKTOPS

Worktops are packed in foil and reinforced with cardboard corners, in part also with fibreboard supports.



**209** TRANSPORT CROSSBARS

Appliance housings with high appliance cut-outs are secured during transport by a transport crossbar. This provides additional stability as long as the appliance is not installed.



**205** PACKING  
PLINTH STRIPS

Plinth strips are packed with cardboard protectors and wrapped with straps at the package ends.



**210** PROTECTIVE FOIL

Fronts with sensitive finishes, for example high gloss fronts, are protected during production and installation with a special protective foil.



**206** PACKAGING  
CORNICE STRIPS | LIGHT STRIPS

The outer corners of cornice strips are factory-glued and completely wrapped in cardboard and strapped. As a transport safety device, the strips are fastened to a piece of carrier cardboard.



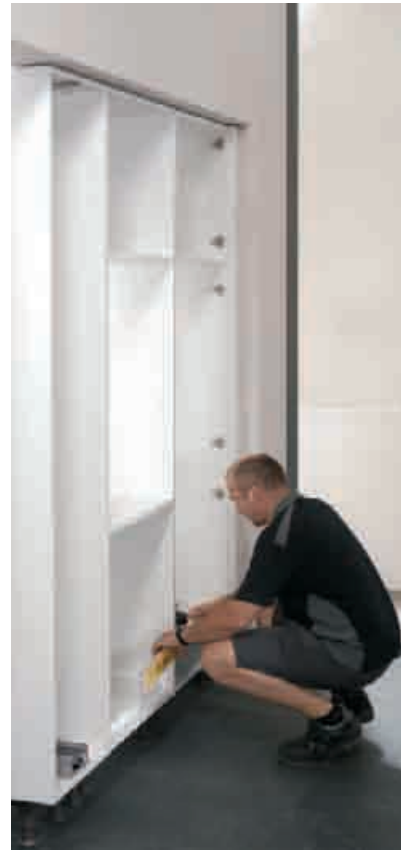

**211** UNITS  
PRE-ASSEMBLED

All units and interior equipment are delivered fully assembled. This saves installation time.



**212** INSTALLATION-FRIENDLY  
SYSTEM

The nobilia kitchen system is characterised by its absolute ease of installation. Beginning with corner units that can be disassembled

to get through narrow stairwells to the fine adjustment of the plinth and fronts, and to the quick mount hinges for doors.



**213** INSTALLATION  
INSTRUCTIONS

For all installation procedures you will find detailed installation instructions for every commission and of course also at our web page: [www.nobilia.de](http://www.nobilia.de) in the menu item Service.

## NOBILIA QUALITY MANAGEMENT

Quality objectives at nobilia are defined company-wide. The quality management is preventively and consistently in place covering the entire process chain. From the preliminary supplier to the final installation of the nobilia kitchen at the end customer's premises – nobilia's quality management has the continual improvement of the entire process in focus. With this holistic approach nobilia has maintained their position as quality leader in the industry over many years. The guidelines for quality and environmental management are deep-seated in the company philosophy and the corporate culture at nobilia. For production this means: mistakes in production must be prevented, defective products are not to leave the factories at all. All quality assurance measures and quality tests at nobilia are strictly enforced throughout all departments in the company and serve to prevent, analyze and correct mistakes.

## 214 TOPFIT FOR EVERYDAY USE

nobilia kitchens are up to the challenge of daily use; all products have already proven their worth in nobilia's QC test laboratory.



## 215 THE "GLASS" LABORATORY

The significant effort that nobilia invests in the QC Test Laboratory prior to production is visible even to the customer. The "Transparent Test Laboratory" has been incorporated into the nobilia in-house exhibition and is, of course, absolutely visible.

The 230 m<sup>2</sup> area allows visitors to gain insight into the comprehensive testing methods that the new products at nobilia must undergo and pass prior to being considered ready for production.



## 216 PRODUCTION- ACCOMPANYING TESTS

In order to ensure a consistently uniform series-production quality, the current series is monitored. This means that in predetermined intervals, production-accompanying tests are performed on the furniture or individual components.

The laboratory equipment is unique for a furniture manufacturer: nobilia can and does perform all their own compulsory tests meeting DIN standards and DGM (German furniture quality seal) requirements are possible and are performed by nobilia itself.

## 217 QUALIFIED EMPLOYEES

A quality management team of 19 ensure that the nobilia quality standards, that exceed both the national and international standards, are met in the areas of customer service, supplier management,

goods received, in-production inspection and test laboratory. Thereby, nobilia strictly and consistently addresses the requirements and the needs/wants of the trade and the end customer.

Only furniture that has passed the qualification tests in the nobilia test laboratory are accepted into the new collection. In this manner, nobilia customers are guaranteed that all new features/products meet the same high nobilia level of quality to which they are accustomed.

Frank Diestel,  
Director of Quality Management

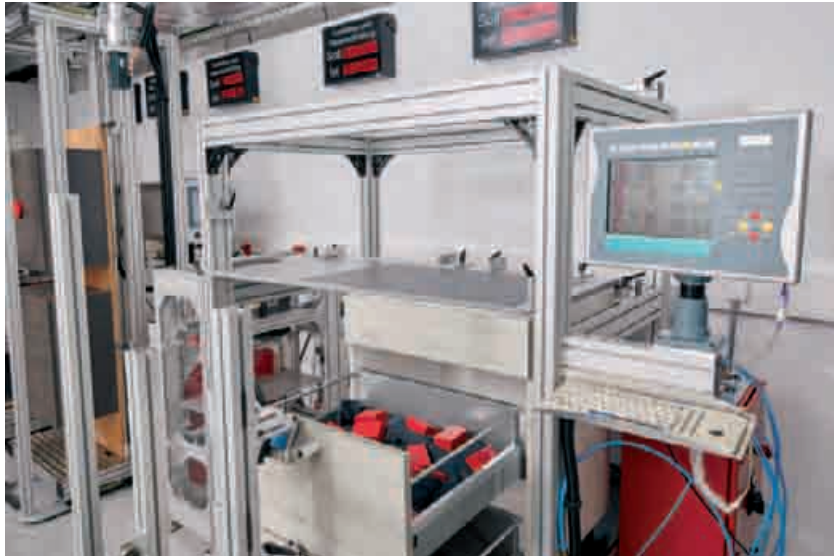

## 218 SERVICE LIFE AT LEAST 15 YEARS

Customer suggestions and requests as well as practical experience and the results of our own studies are an ongoing and essential part of the development process. All the materials we use are tested for a minimum operating life of 15 years.

## 219 ONLY FULLY DEVELOPED PRODUCTS ON THE MARKET

New developments are subjected to extensive testing in the laboratory before they ever make it to series-production.

## ROBOTIC TEST STATION

### DAILY KITCHEN ROUTINES UNDERGO ENDURANCE TESTING!

Our robot is an all-round talent. He can be programmed so that his functions and movements correspond to the real work actions in a kitchen. Such as: opening and shutting the swivel flap doors and folding flap doors, opening and shutting the full pull-out, opening and shutting the hinged doors. 15 years of daily kitchen use are thus simulated in fast motion under realistic conditions.

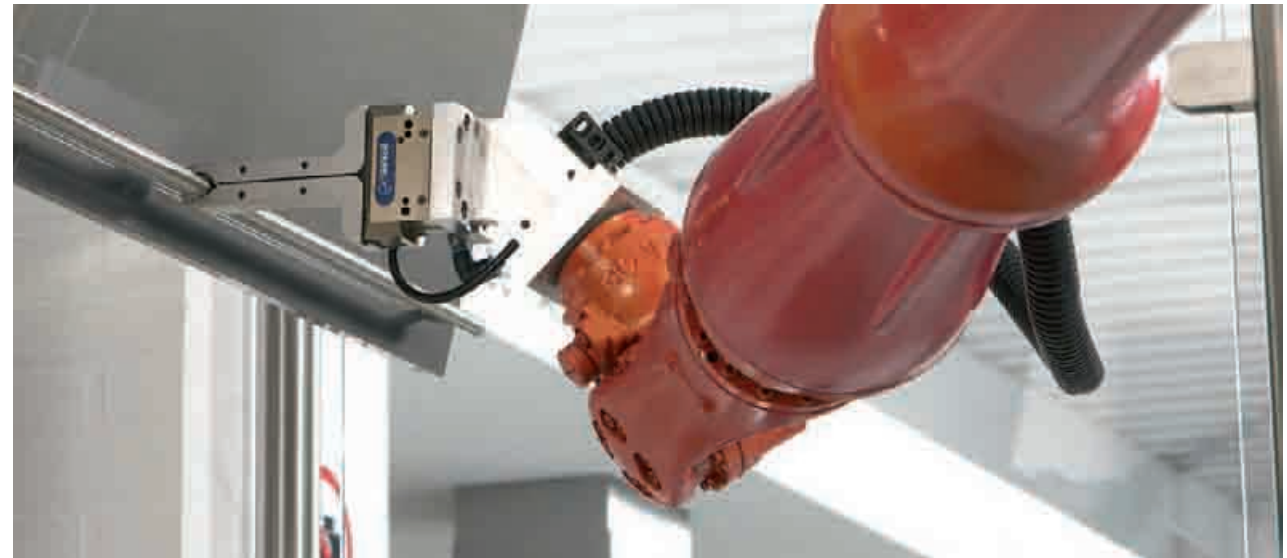

220 60,000 TIMES  
IN TWO WEEKS

Doors and pull-outs undergo opening and closing with at least 60,000 load cycles by robots. With this number, nobilia meets the strict guidelines of the DGM for the RAL seal of quality "Goldenes M" (the golden M).



## STATIC LOAD

There are guidelines for virtually everything. Our entire lives are for the most part regulated by standards. Though at times this can be confusing, it is however, helpful when you are dealing with the sturdiness, longevity and safety of kitchen furniture. Exactly what kitchen furniture must withstand is specified in the respective DIN standards. For maximum safety and in consideration of a long service life, nobilia's self-imposed standards often far exceed what is required. In the laboratory we continually test the load bearing capacity of top and bottom shelves and loose shelves on the load-bearing wall.



## 221 75 KG BEARING LOAD PER WALL UNIT

The wall suspension and wall unit construction are designed to hold 75 kg. This is far more than conventional tableware weighs: An 18 piece coffee set made of porcelain, for instance, has an average

weight of roughly 5 kg. Put another way, we are talking about the weight of a coffee set that would serve 90 people.

IN GREAT DEMAND...

We test hinged doors, pull-outs and larder units - in short, all moving components, in continuous operation for a total life-span of more than 15 years and - for us indispensable - and always with full capacity. In the process, we put stress and strain on our furniture in the QC laboratory, at times, up to three times longer than required by the DIN standards.



**222** LARDER UNIT

- 60,000 - 80,000 load changes depending on load
- This equates to approx. 11 to 15 times the amount of opening and closing performed in a day.

**223** CAROUSEL CORNER UNIT

- 60,000 load cycles
- This equates to approx. 11 times the amount of opening and closing performed in a day.



# FUNCTION TESTING AND CONTINUOUS OPERATION TESTING

Morning, noon and night, there is always someone using my kitchen. Doors open, doors closed, food supplies stored in the larder unit, cutlery put away and pulled out – our kitchen doors and pull-outs have to stand up to a lot. It is certainly beneficial to have a quality kitchen that has been tested in the manufacturer's own laboratory for virtually everything.

Jan Cordes,  
Trade visitor



## 224 DRAWERS PULL-OUTS

- 60,000 – 80,000 load changes
- This equates to approx. 11 to 15 times the amount of opening and closing performed in a day.



## 225 HINGED DOORS

- 80,000 load cycles
- This equates to approx. 15 times the amount of opening and closing performed in a day.



## 226 ROLL-UP FRONTS

- 60,000 load cycles
- This equates to approx. 11 times the amount of opening and closing performed in a day.



## THE LATEST FROM THE WITCHES' KITCHEN

The kitchen is at the heart of life. And is thus expected to perform: it has to hold up to aggressive substances like citric acid or highly staining liquids. In order to test surfaces for their ability to withstand daily wear we subject them to chemical testing and abrade them with rough and sharp objects, and even simulate long-term wear on the handles tens of thousands of times. Only then does the surface of a nobilia kitchen really show what it can withstand.



### 227 CHEMICAL-RESISTANCE

During so-called agents testing, applied agents are left on the surface for a predetermined period of time according to wear group.  
For instance:  
acetone 10 seconds, vinegar 1 hour, coffee 16 hours, olive oil 16 hours.

### 228 ABRASION TEST FURNITURE SURFACES

This test measures the abrasion resistance of the decorative surfaces. Continuous sanding with a defined applied weight and abrasive grit simulates wear of the surface.



### 229 SCRATCH TEST

A diamond point is pressed onto the rotating test specimen with increasing force. The scratches resulting on the test specimen are visually assessed with the viewing device.

230 CONDENSATION WATER  
CONSTANT CLIMATIC TEST

Components (e.g. painted attachment parts, metallic components) are kept in a water bath at a constant test room temperature of 40°C.

The constant humidity (100% relative humidity) created in the test chamber serves for testing the resistance of components to climatic influences / humidity.



With our tests and trials we have far exceeded the required DIN and DGM standards. This means, components that have passed the test also have an above-average service life. Thus, we give the buyer of a nobilia kitchen the security that they have purchased a superior quality kitchen.

Oliver Wessel,  
Head of QC Laboratory



231 SALT SPRAY TEST

Metallic components such as handles are exposed to extremely aggressive corrosion through salt spray. The objective: even after this test the components cannot show any signs of corrosion.

232 ABRASION TEST  
HANDLES

A cowhide strip loaded with ball bearings is moved over the handle surface in the testing device. This test simulates the abrasive wear on a handle over a period of 15 years.

## STORAGE UNDER CLIMATIC STRESS

During the climate test we simulate various climatic influences. For instance, the conditions of a container transport over sea, installation of the kitchen in a tropical climate as well as long-term simulations and accelerated ageing tests. All furniture components are subjected to various climatic tests.

## ARTIFICIALLY ACCELERATED AGEING

In addition to the climate test, the climatic exposure test cabinet can also be used to simulate the ageing process. Just like in a time machine, we simulate changing climatic forces and allow the new components to age artificially. Here, 15 years pass in just 270 hours. The objective: high resistance even under extreme conditions.



### 233 CLIMATIC TEST

The climatic test incorporates extreme changes in temperature and humidity over multiple cycles in accordance with the respective DIN standards.



### 234 COLD CHECK

The paint-bonding properties are tested with extreme temperature fluctuations: first, at -20° C Siberian cold for 16 hours and then at the extreme heat of 50° C for 8 hours.



With a so-called cross-cut adhesion test we determine to what degree the paint coating has reacted to the temperature changes.

## WE GET YOU ALL STEAMED UP!

Moisture, heat, cold! In the daily life of the kitchen, the individual components must withstand all these external influences. With the steam test evaluation, for instance, we test the resistance and impermeability of carcase and front component edges to water vapour.



### 235 RESISTANCE TO WATER VAPOUR

Components are subjected to a so-called vapour deposition tower five times in a row for 30 minutes each time. Swelling or detachment of the edge is not permitted.



The decorative surface of worktops is subjected to direct steam above boiling water for 1 hour. Colour changes and surface damage are not permitted.

## TURN ON THE WATER!

Water is the worst enemy of kitchen furniture. A well-made carcase, worktop and front must be able to withstand daily wear over a long period of time. We test for the resistance and impermeability of edged materials with submersion in a water bath.



### 236 WATER BATH TEST

According to nobilia testing guidelines, the components stay for two hours with the test edge submerged in a water bath. Changes to the component such as swelling damage or tears are not permitted even after this period of time.

The test is performed in accordance with nobilia's own testing standard and is also performed as series-accompanying tests during production.

EVERY KITCHEN FRONT MUST BE ABLE TO WITHSTAND 10 YEARS WORTH OF SUN ON THE ISLAND OF SYLT!

We even test our furniture surfaces for this. Using a Xenon arc lamp in the laboratory we simulate the amount of UV irradiation that a kitchen would be subjected to over the years. This allows us to artificially age the surfaces. That way, we can accurately determine the degree of discolouration in the time elapsed and avoid such large deviations in the first place.



237 SUN TEST

The characteristics of the irradiated surface are compared with the characteristics of those surfaces which were covered.

- A grey scale in accordance with DIN EN 20105 is used for the assessment.
- The test procedure is described in DIN EN 15187.

COLOUR FIDELITY OF THE RANGE

In order to eliminate colour deviations from series production surfaces, we test our materials under different standard light types and compare these with specified colour standards (Metamerism Index). In this process we evaluate the surfaces in daylight, artificial light and fluorescent light.

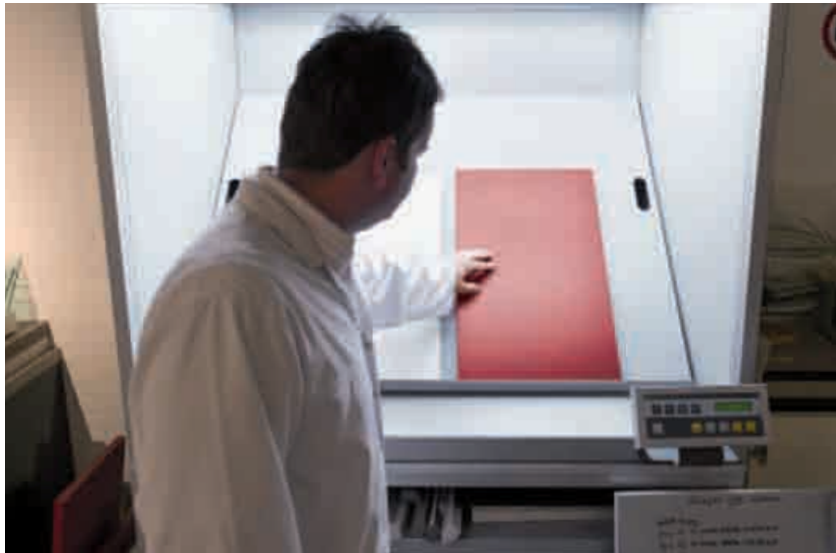

238 STANDARD LIGHT TEST

The reliable evaluation of colour and degree of gloss is very important, for instance, when one is dealing with reorders from other batches. The colour accuracy must be ensured and the degree of gloss must always be the same.

DANGER, HOT!

How much heat can a worktop withstand? Anyone who has ever left a hot pot sitting on the worktop is familiar with this situation. For a while the worktop can withstand it, but at some point a burn ring forms. We test the limits of the materials resistance under extreme conditions in the laboratory.



239 HEAT TEST  
WET AND DRY

We test the heat resistance of worktops in accordance with DIN 68930:

- Heat resistance to dry heat up to 180°C
- Heat resistance to moist heat up to 100°C

# GOOD DESIGN FOR EVERY TASTE

The product designers at nobilia know very well how to design kitchens that speak to the lifestyles of a broad consumer base. This allows nobilia to reach roughly 80 percent of the market.

The goal is to fulfil the increasingly individualised wishes of customers with excellent kitchens that meet their everyday needs at an affordable price.



## 240 YOUR SINGLE-SOURCE PROVIDER

nobilia offers their dealers a complete package, comprised of furniture, appliances, sinks and kitchen accessories. 12 Name brand appliances from entry price level to

premium segment are available. Exclusive appliances and brand names provide potential for differentiation from Internet marketing forms.

## 241 QUICK MARKETING

Our new features are already available directly after the in-house exhibition. Thus, they are available to the trade already during the important end-of-year business.



242 | PRODUCT DEVELOPMENT TO THE POINT

nobilia develops their products pinpointed to the relevant price ranges. What is remarkable about this: due to the high sales and production figures,

the company is able to profitably implement outstanding quality features for the broad market.



PG 1



PG 2



PG 3

For over 70 years, nobilia has focussed on production of kitchens for the middle segment of the market. The company covers roughly 80 % of the market, in terms of price levels as well as styles. Strategically important colours are available

in all market relevant price levels and materials. No other manufacturer covers this variety with only a single sales channel.



PG 4



PG 5



PG 6



PG 7



PG 8

243 | SELF-CONFIDENT STYLE

With nobilia on their side, business and trade partners are well-positioned in the market. The company offers a broad spectrum – from modern and trendy to classic and timeless and on to Mediterranean cottage style. The right product for every taste.

244 | TAKE IT EASY

A cleverly structured and logically configured range of types offers tailored planning solutions – made-to-measure for every kitchen floor plan.

245 | UNLIMITED POSSIBILITIES...

... for your dream kitchen:

- 2,300 Units
- 86 Fronts
- 82 Handles
- 17 Carcase colours
- 98 Upright colours
- 46 Worktop décors

The result is a virtually unlimited number of custom design possibilities.



PG 9



PG 10

ONE PRODUCT TO FULFIL ALL WISHES

# A LASTING RELATIONSHIP

One face to the customer - that is the law at nobilia! Every trade partner has their own personal contact person who is responsible for their order processing and thus,

knows their telephone counterpart very well. This helps to prevent misunderstandings and ensures smooth order processing that customers can trust.



## 248 FOR YOU ON SITE

nobilia Field Service Agents have learned their job from the ground up. For this reason, your contact partner on site brings well-grounded experience in the trade - and sometimes also training in a skilled trade with them to their job. A total of

roughly 82 staff members are employed in Field Sales, 38 of whom service the customers in the domestic market. The Field Services Information System (FSIS) delivers precise (to the day) statistics and key data for the sale.

## 246 ONE LOOK CONTROL

Every single customer order is graphically documented and electronically inspected for possible planning mistakes. The order confirmation is a quick and clearly arranged form of control for the salesperson because in addition to detailed item lists and a floor plan sketch, the order confirmation also contains wall views and a perspective representation. Subsequent alterations to the first job confirmation are clearly marked.



## 249 SAFE AND EFFICIENT

Using direct electronic communication via EDI and Extranet reduces internal handling processes to a minimum. In this way, nobilia kitchens can be on their way to our trade partners more quickly and reliably.

## 247 A LASTING RELATIONSHIP

Over 230 customer service representatives, in the Administrative Services Department alone, are available for our 8,000 customers worldwide. They demonstrate both their technical and business competence in quickly, reliably and efficiently reviewing and processing job orders and handling all facets of the customer order.



## 250 ALWAYS UP-TO-DATE

On the nobilia Extranet you have your OC s and delivery dates available at all times: seven days a week - 24 hours round the clock.

# SERVICE FROM THE PHOTO TO THE POS.

## 251 EVERYTHING AT A GLANCE

Just one Sales Manual for all three classical marketing models:

- Full Service Marketing
- Furniture Only Marketing
- Free Marketing of Products



## 252 ONE SALES MANUAL, TWO GRID SYSTEMS

With a single Sales Manual and a single sales line, nobilia serves both established grid systems on the market. One list, one logic – that simplifies operations in daily sales.



## 253 ONLY ONE SALES MANUAL, EVEN FOR HANDLE-LESS KITCHENS

The entire range of handle-less kitchens is clearly arranged and compactly compiled in a chapter of the nobilia Sales Manual. One list, one logic, one kitchen block pricing method–this also applies to LINE N.



Trade partners can also count on nobilia for marketing and sales support at the point of sale. Whether Sales Manuals, flyers or sales journals – the latest promotional materials are always available as soon as the new collections are. Upon request, nobilia will take over the planning of entire exhibitions for our trade

partners, from the shop construction to the layout of walkways and to the sales consultant workspaces. Every year there are roughly 21,500 display kitchens in the trade, approx. 500 complete customer showrooms are planned by the nobilia Creativ-Studio.



## 254 INDIVIDUALISED SALES PROMOTION

Each year our in-house photography studio creates a large number of attractive ads. The nobilia photo archive currently contains some 8,000 motifs, with more than 400 new ads being added each year.



## 255 OWN FLYERS

Offerings from 22 different leaflets for specialised dealers. Individualised consultation and adaptation by professional advertising agencies is possible at any time. The largest core edition of more than 200 million brochures annually guarantee attractive sales conditions.



## 256 PROFESSIONAL INSTALLATION

In Germany there are 115 highly qualified installation partners who have been trained by nobilia and are available to install customers displays. For overseeing large-scale construction our own plant fitters will also be brought in.



## 257 TRAINING PROGRAMMES

With seven different seminar modules, nobilia offers specialised dealers a comprehensive range of seminars. Annually some 3,000 attendees from the Sales and Installation divisions



take part in the training programmes. The training sessions take place in professionally equipped training rooms and in the nobilia showroom.

258 PROFESSIONALISM EVERYDAY

More than 3,000 finished kitchens leave the two plants in Verl per day, which corresponds to an annual production rate of just under 660,000 kitchens.

259 AUTOMATED INDIVIDUALITY

Each nobilia kitchen is totally unique - individually planned and yet manufactured using highly automated production processes. Attribute this to nobilia's remarkable know-how!

260 ATTRACTIVE: VALUE FOR MONEY

A well-designed modular construction system is the foundation for an individually planned fitted kitchen in a lot size of one.

The high degree of automation in production ensures the attractive value for money.



261 OWN VEHICLE FLEET

All our deliveries are made with our company-own vehicle fleet. Our highly qualified drivers ensure professional and experienced furniture transportation at all times. Every delivery comes with advance notice.

262 PLAYING IT SAFE

nobilia achieves an extremely high degree of delivery reliability using scanners during loading and unloading. With an incorrect delivery rate of only 0.33% and a delivery dependability rate of roughly 98.73%, the company-own vehicle fleet thus achieves peak values for the furniture industry.

# OUR EXPERIENCE FOR YOU – 70 YEARS OF TRADITION AND PRODUCTION IN GERMANY



Seven decades of experience in kitchen manufacture is not without its advantages. This sense of tradition has decidedly formed nobilia. Above all, nobilia employees understand their craft. And that has taught the company that a consistent

orientation toward future market developments is indispensable to success. The whole of this combined knowledge flows into measures that guarantee a constant high standard of quality as well as maximum production automation

and process reliability. With each and every year nobilia has set new, higher standards in kitchen manufacture. Innumerable further developments have been initiated and successfully implemented by nobilia.

## 263 AROUND THE WORLD EVERY DAY

Driving approx. 82,000 kilometers per day, the nobilia vehicle fleet covers a route equivalent to circling the earth twice every day. Roughly 2.45 million m<sup>3</sup> freight volume and 27.2 million load positions are delivered around the world annually. In addition, well over 1,600 sea containers are delivered to overseas customers each year.

## 264 QUICK DELIVERY TIMES

Even though the greatest pleasure is in the anticipation, we won't keep you waiting that long! We usually deliver complete commissions in only three weeks, and complaints are resolved often within 10 working days.



# NOBILIA SETS STANDARDS

## NOBILIA SETS STANDARDS

As a provider operating world-wide, nobilia feels highly responsible for customers and employees, products and production processes. The quality of our products and services is our prime objective. The clear focus on quality and customer benefits is an essential prerequisite to our success. However, nobilia's strength lies not only in its technologies and products, but more than anything else, in its employees. Health and well-being are the basis for our employees' productivity and motivation. Occupational safety and environmental protection must be guaranteed at all times. We wholeheartedly embrace the principle of taking responsibility for the future. This is an inherent part of our thinking and doing business. In doing so, we take into account economical, ecological and social issues in equal measure.

## 265 THE FIRST ONE THERE



**DIN EN ISO 9001:2008 Certified Quality Management**  
ISO standards are standards that are valid in all of Europe and recognised worldwide. In accordance with DIN EN ISO 9001:2008 the quality management systems of a company are evaluated in their entirety. The central idea of quality management is to analyse customer requirements and to establish and monitor processes, in order to produce products in accordance with market demands. The certificate has market-strategic significance and guarantees the future of a reliable customer relationship. In 1994 nobilia was the very first kitchen furniture manufacturer in Germany to become certified. In March 2016 the QM certificate DIN EN ISO 9001:2008 was reconfirmed.

## 266 IT IS OUR PLANET



**DIN EN ISO 14001:2009 Certified Environmental Management**  
The DIN EN ISO 14001 is the certification standard of environmental management systems recognised worldwide. Since 2007 nobilia has been successfully undergoing the environmental certification process in accordance with this ISO standard, which particularly emphasises environmental protection and conservation of natural resources. The assessment comprises the company environmental policies, its verifiable environmental goals and the company-wide environmental programme designed to achieve them. The ISO environmental standards require an environmental management system that regulates planning, implementation, controls and improvements within the framework of a continual improvement process. The certificate is an essential prerequisite for success in many markets. With it, nobilia offers their trade partners the reliability of a sustainable, certified environmental management. In March 2016 the QM certificate DIN EN ISO 14001:2009 was reconfirmed.

## 267 ENERGY MANAGEMENT SYSTEM



**DIN EN ISO 50001:2011 Certified Energy Management System**  
The subject of energy (costs) is becoming increasingly important, in the private sector as well as in the production sector in particular. For this reason, nobilia has made it a priority to use its energy (electricity, gas, wood, oil, diesel, etc.) optimally and carefully, as well as in an ecologically sound manner, and where possible, to save energy. nobilia encourages consistent energy management by developing suitable measures within the framework of continual energy improvement processes.

## 268 OUR RESPONSIBILITY



**PEFC/04-31-1281**  
Since July 2009 nobilia is the first kitchen manufacturer certified in accordance with PEFC (Programme for the Endorsement of Forest Certification Schemes). This certification documents nobilia's commitment to a livable environment and takes responsibility in handling precious wood resources. Because the wood materials we use come from sustainably managed forests and controlled sources. Forest certification provides the guarantee that the wood products you purchase do not derive from questionable sources or over-exploitation, but rather originate from forests that are managed in harmony with nature. The purchase of a PEFC certified nobilia kitchen demonstrates the buyer's sense of responsibility for our environment.





269 BLUE ANGEL ECO-LABEL (BLAUER ENGEL)

In July 2012 the company was the first and to date only kitchen furniture manufacturer to receive the official environmental seal of the "Der Blaue Engel" (the blue angel). This mark of the German Federal Ministry of the Environment promotes the values of environmental and health protection as well as those of consumer protection. It distinguishes products and services that are of particular benefit to the environment from a holistic perspective and at the same time, that meet high standards of serviceability as well as health and occupational protection. The "Blauer Engel" was awarded to the following ranges: Aviano 753, Chalet 977, Cottage 153, Credo 545, Feel 314, Flair 636, Flash 648, Focus 312, Gloss 102, Highlight 933, Laser 615, Lux 555, Pura 917, Rio 253, Riva 371, Speed 351, Structura 382, Targa 676, Touch 317, Vetra 149, Xeno 757 and York 985.



270 THE GOLDEN M

**RAL Quality Seal 430**  
This quality seal is awarded by the Deutschen Gütegemeinschaft Möbel e.V. (German furniture quality seal). The strict requirements of the DGM far surpass those of national and international standards and distinguish products of above-average quality. Quality tested and approved furniture must be sturdy, safe, durable and well-made - and it cannot contain any ingredients deemed hazardous to health. Meticulous tests and strict controls ensure that furniture with the RAL quality seal adhere to the extensive criteria. The German "Golden M" counts both nationally and internationally as one of the most distinguished quality certificates issued based on the most stringent criteria. For consumers it means certainty that a product is of first class quality and has been manufactured in an environmentally safe manner. The long-standing, intensive

271

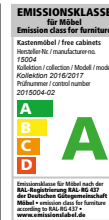

EMISSION CLASS DGM

Having met all award requirements, nobilia's kitchen furniture was awarded the highest emissions class of A by the Deutschen Gütegemeinschaft Möbel e.V. (German Association of Quality Furniture).

cooperation between DGM, the Deutschen Verbraucherzentrale (German consumer protection agency) and the Stiftung Warentest (German non-profit organisation for independent product testing) is an important basis of trust for the consumer.

272 DGM CLIMATE AGREEMENT



Nobilis was the first kitchen manufacturer to join the new "climate agreement for the furniture industry" when the DGM - Deutsche Gütegemeinschaft Möbel (German Association of Quality Furniture) established it at the beginning of 2016. This action underscores once again nobilia's sense of responsibility for the environment and the climate objectives of the German government as well as those of the United Nations. The DGM climate agreement is based on the calculation of the company's CO2 footprint. This footprint is continually analysed in cooperation with an environmental protection consultant.

273 PLAYING IT SAFE



**GS (Geprüfte Sicherheit) mark for tested safety**  
This certificate is awarded by the LGA Nuremberg. The LGA belongs to the TÜV Rheinland Group (international service group) and is Europe's largest and most important furniture testing organisation. The GS mark for tested safety is a voluntary safety mark that has significance far beyond the borders of Germany. In the area of consumer protection and occupational health and safety it is the guarantee that the safety-related requirements have been met and reviewed by an independent body such as the LGA and will also be regularly monitored. LGA quality certificates for furniture, furniture parts, components and accessories is an identifying feature for tested and controlled quality and product safety.



