



Overview of elements 2022

Ordering correctly

Necessary Order Information

Complete and accurate data is absolutely necessary for the processing and production of your order, since an accurate and clear order allows us to immediately begin processing your order without time-consuming enquiries.

For this reason, your order must contain the following information:

- Range name and front number
- Handle number
- Drill pattern number
- Carcase colour number
- Plinth height and colour
(if not specified, the standard plinth height of 150 mm will be supplied)
- Worktop design / décor
- Worktop edge design / edge colour
- Worktop sketch with dimensions and indication of tongue and groove joints
- Design of the worktop outer corner (for APD): square or round
- Upright / top shelf design including the colour number and upright thickness / Upright panel floor seal colour
- Shelf colours
- Glass design and / or colour
- Roll-up front colour
- Cornice profile / light pelmet profile including colour for each
- Order number and / or abbreviation
- Manufacturer information and built-in appliance model identification
- Kitchen block number (for kitchen block orders)
- Layout sketch with dimension information in 1:20 ratio
- Please draw / write any special productions in the centre of the layout sketch

Dimensional drawings for upright panels

Uprights at end of run for base units, sideboards and tall units are supplied as standard with an upright panel shoe. The upright panel shoe is included in the price of the upright panel and is available in: 014 Stainless steel appearance, 010 Black. If no colour is specified in the order, the version 014 Stainless steel appearance will automatically be supplied.

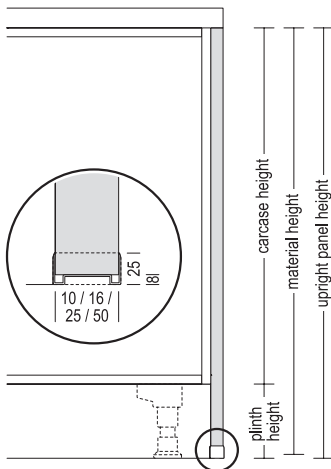

The height of the upright panel is reduced by the interior height dimensions of the profile and thus calculated as follows:

$$\begin{aligned} & \text{carcase height} \\ & + \text{plinth height} \\ & - 8 \text{ mm interior chamfering of the floor profile} \\ & = \text{material height} \end{aligned}$$

Base units

Carcase depth: 561 mm
 Carcase height: 720 mm
 Plinth height: 70, 100, 150 or 200 mm

Base units

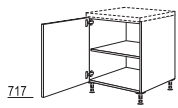

Base unit
 1 continuous door,
 1 shelf

717
UD 20/30/40/45/50/60 cm

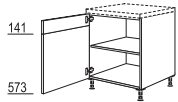

Base unit
 1 pinned door,
 1 shelf

141
 573
U 20/30/40/45/50/60 cm

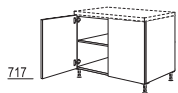

Base unit
 2 continuous doors,
 1 shelf

717
UD 80/90/100/120 cm

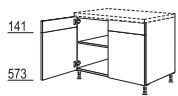

Base unit
 2 pinned doors,
 1 shelf

141
 573
U 80/90/100/120 cm

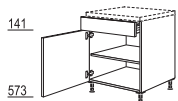

Base unit
 1 drawer,
 1 door,
 1 shelf

141
 573
US 30/40/45/50/60 cm

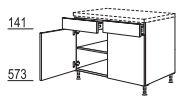

Base unit
 2 drawers,
 2 doors,
 1 shelf

141
 573
US 80/90/100/120 cm

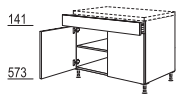

Base unit
 1 drawer,
 2 doors,
 1 shelf

141
 573
USG 80/90/100/120 cm

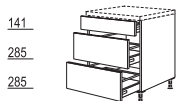

Pull-out unit
 1 drawer,
 2 pull-outs

141
 285
 285
UA 30/40/45/50/60/80/90/100/120 cm

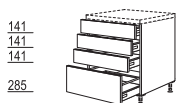

Drawer unit
 3 drawers,
 1 pull-out

141
 141
 141
 285
U3SA 30/40/45/50/60/80/90/100/120 cm

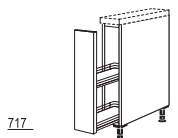

Pull-out unit
 1 pull-out,
 1 continuous front,
 2 hanging baskets with
 wooden bottoms

717
UAMD 20/30 cm

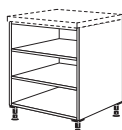

Open shelf base unit
 2 fixed shelves,
 side depth: 582 mm

UR 15/20/30/40/45/50/60 cm

Corner base units

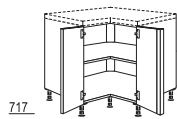

Corner base unit
 2 continuous doors,
 opening angle: 165°,
 1 shelf

717
UDTE 80/90 cm

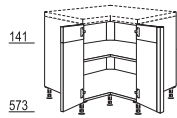

Corner base unit
 2 pinned doors,
 opening angle: 165°,
 1 shelf

141
 573
UTE 80/90 cm

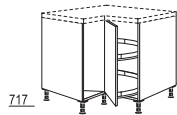

**Corner base unit as
 carousel unit**
 2 continuous fronts,
 carcase height: 750 mm,
 1 revolving carousel with
 2 wooden shelves and
 metal railing, rotates 360°,
 height adjustable top shelf

717
UEDK 80/90 cm

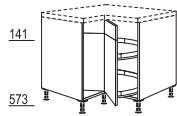

**Corner base unit as
 carousel unit**
 2 pinned fronts,
 carcase height: 750 mm,
 1 revolving carousel with
 2 wooden shelves and
 metal railing, rotates 360°,
 height adjustable top shelf

141
 573
UEK 80/90 cm

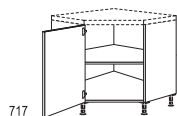

**Chamfered corner base
 unit**
 1 continuous door,
 1 shelf

717
UED 80/90 cm

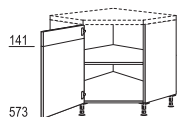

**Chamfered corner base
 unit**
 1 pinned door,
 1 shelf

141
 573
UE 80/90 cm

Half corner base units

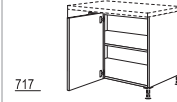

Corner base unit
 1 continuous door,
 1 shelf, 1 angle filler
Carcase widths:
 900, 1000 mm

Planning dimensions:
 650 - 750 x ...
UED90-40
UED90-45
UED100-50
UED100-60
 UED90-40...x 1050-1150 mm
 UED90-45...x 1100-1200 mm
 UED100-50...x 1150-1250 mm
 UED100-60...x 1250-1350 mm

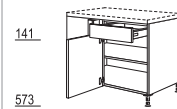

Corner base unit
 1 drawer, 1 door,
 1 shelf,
 1 angle filler
Carcase widths:
 900, 1000 mm
Planning dimensions:
 650 - 750 x ...
UE90-40
UE90-45
UE100-50
UE100-60
 UE90-40...x 1050-1150 mm
 UE90-45...x 1100-1200 mm
 UE100-50...x 1150-1250 mm
 UE100-60...x 1250-1350 mm

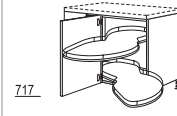

**Corner unit with
 swivel pull-out**
 1 continuous door,
 2 tablar shelves
 with metal railing,
 height adjustable,
 1 angle filler
Carcase widths:
 900, 1000 mm
Planning dimensions:
 650 - 750 x ...
UEDSA90-45
UEDSA100-50
UEDSA100-60
 UE*90-45...x 1100-1200 mm
 UE*100-50...x 1150-1250 mm
 UE*100-60...x 1250-1350 mm

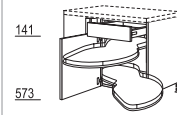

**Corner unit with
 swivel pull-out**
 1 drawer,
 1 door,
 2 wooden swivel tablars
 with metal railing,
 height adjustable,
 1 angle filler
Carcase widths:
 900, 1000 mm
Planning dimensions:
 650 - 750 x ...
UESA90-45
UESA100-50
UESA100-60
 UE*90-45...x 1100-1200 mm
 UE*100-50...x 1150-1250 mm
 UE*100-60...x 1250-1350 mm

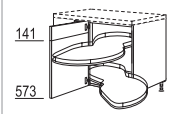

**Corner unit with
 swivel pull-out**
 1 pinned door,
 2 tablar shelves
 with metal railing,
 height adjustable,
 1 angle filler
Carcase widths:
 900, 1000 mm
Planning dimensions:
 650 - 750 x ...
UESAV90-45
UESAV100-50
UESAV100-60
 UE*90-45...x 1100-1200 mm
 UE*100-50...x 1150-1250 mm
 UE*100-60...x 1250-1350 mm

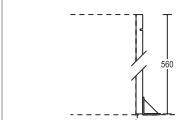

**Surcharge for
 dishwasher recessed filler**
 on fillers and half-corner
 units, side panel made of
 carcase material,
 carcase depth: 561 mm

MP-GS

Base units

Carcase depth: 561 mm
 Carcase height: 720 mm
 Plinth height: 70, 100, 150 oder 200 mm

Angle fillers

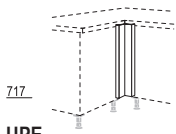

UPE
UPE-V

Angle filler

Continuous front material, 70 x 70 mm, planning dimensions: 650 x 650 mm

as above, however **variable** from 50 to 170 mm, planning dimensions: 630 - 750 mm
 1st dimension = left / 2nd dimension = right

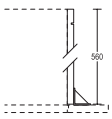

MP-GS

Surcharge for dishwasher recessed filler on fillers and half-corner units, side panel made of carcase material, carcase depth: 561 mm

Fillers / Panelling

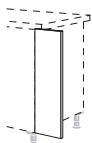

UPK 10/20 cm

Filler

Carcase material, 720 mm high, U-shaped seal for connection to wall width: 100/200 mm

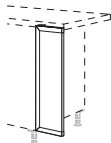

UPD 20 cm

Front filler

Continuous front material, width: 200 mm

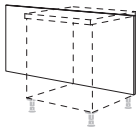

RK-72

Base unit back panel

16 mm thick, 720 mm high, width: 250 - 2000 mm, available in all carcase and worktop décors from décor group 1, Vario clip fastening, in case of reproduction finishes vertical wood grain

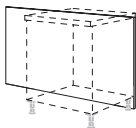

RKS-72

as above, however, continuous height, including floor profile: 70 mm plinth height: 810 mm
 100 mm plinth height: 840 mm
 150 mm plinth height: 890 mm
 200 mm plinth height: 940 mm

Available floor profile colours:

010 Black
 014 Stainless steel appearance

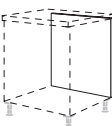

RFD-72

30/40/45/50/60/80/90 cm

Cooker housing

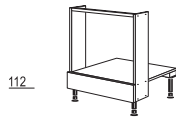

HU 60 cm

Cooker housing

1 fixed panel, side sections: 177 mm deep, aperture dimension: 591 mm

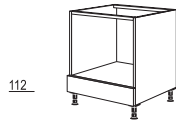

HUB 60 cm

Cooker housing

1 fixed panel, aperture dimension: 598 mm

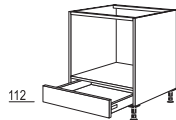

HUS 60 cm

Cooker housing

1 plastic drawer, 16 l capacity, interior dimensions: 485 x 480 x 68 mm, aperture dimension: 598 mm

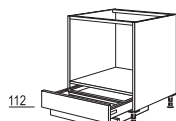

HUG 60 cm

Cooker housing

1 large-capacity drawer with second level for baking trays, plastic, 30 l capacity, interior dimensions: 480 x 380 x 150 mm, aperture dimension: 598 mm

Hot plate units

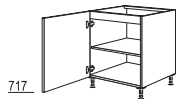

KD60 60 cm

Hot plate unit

1 internal panel, 1 construction shelf for heat insulation, 1 door, 1 shelf

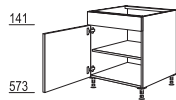

K60 60 cm

Hot plate unit

1 fixed panel, 1 construction shelf for heat insulation, 1 door, 1 shelf



KS60 60 cm

Hot plate unit

1 drawer, 1 spacer shelf for hot plate, 1 door, 1 shelf



KS2A
60/80/90/100/120 cm

Hot plate unit

1 drawer, 1 spacer shelf for hot plate, 2 pull-outs

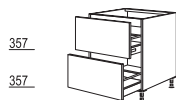

KD2A
60/80/90/100/120 cm

Hot plate unit

1 internal panel, 1 construction shelf for heat insulation, 2 pull-outs

Sink units

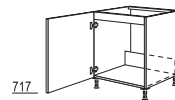

SPUD 40/45/50/60 cm

Sink base unit

1 internal panel, 1 continuous door

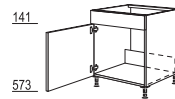

SPU 40/45/50/60 cm

Sink base unit

1 fixed panel, 1 door

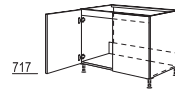

SPUD 80/90/100/120 cm

Sink base unit

2 internal panels, 2 continuous doors

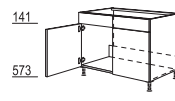

SPU 80/90/100/120 cm

Sink base unit

2 fixed panels, 2 doors



SPUAD
40/45/50/60 cm

Sink base unit

1 internal panel, 1 continuous front with centred handle, without pull-out rails and drill holes

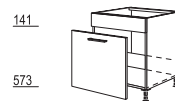

SPUA 40/45/50/60 cm

Sink base unit

1 fixed panel, 1 front with centred handle, without pull-out rails and drill holes

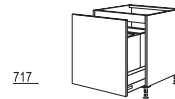

SPUDA-ASK
45/50/60 cm

Sink base unit

Separato-K
 1 internal panel, 1 pull-out, 500 mm deep, with **waste separation system**
Separato-K with pull-out lid, 1 x 18 and 2 x 8 litres, 500 mm width: with 1 side organiser, 600 mm width: with 2 side organisers, 1 bio lid (for all widths)

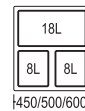

Doors for integrated appliances

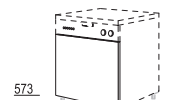

GSB 45/60 cm

Door

for integrated dishwashers, without handle

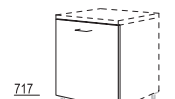

GSBD*-I 45/60 cm

Continuous door

for fully integrated dishwashers, built-under fridge and freezer units with pull-outs

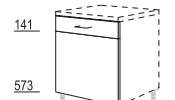

GSB*-I 45/60 cm

Pinned door



for fully integrated dishwashers, built-under fridge and freezer units with pull-outs

Base units in XL height



Carcase depth: 561 mm
 Carcase height: 792 mm
 Plinth height: 70, 100, 150 or 200 mm

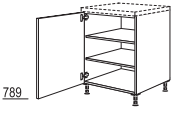
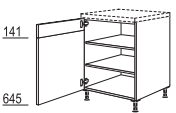
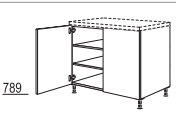
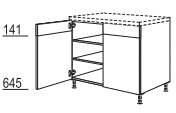
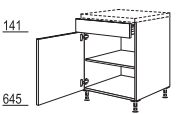
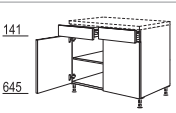
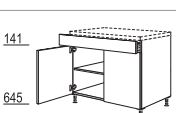

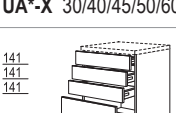
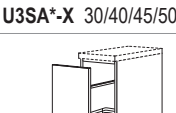
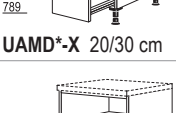

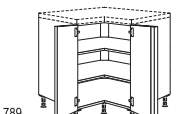
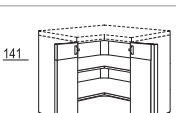
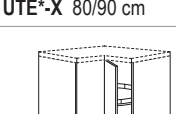
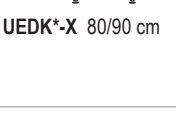

XL Base units

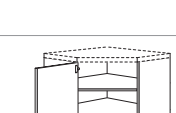
	XL Base unit 1 continuous door, 2 shelves
789	UD*-X 20/30/40/45/50/60 cm
	XL Base unit 1 pinned door, 2 shelves
141 645	U*-X 20/30/40/45/50/60 cm
	XL Base unit 2 continuous doors, 2 shelves
789	UD*-X 80/90/100/120 cm
	XL Base unit 2 pinned doors, 2 shelves
141 645	U*-X 80/90/100/120 cm
	XL Base unit 1 drawer, 1 door, 1 shelf
141 645	US*-X 30/40/45/50/60 cm
	XL Base unit 2 drawers, 2 doors, 1 shelf
141 645	US*-X 80/90/100/120 cm
	XL Base unit 1 drawer, 2 doors, 1 shelf
141 645	USG*-X 80/90/100/120 cm
	XL Pull-out unit 1 drawer, 2 pull-outs
141 285 357	UA*-X 30/40/45/50/60/80/90/100/120 cm
	XL Drawer unit 3 drawers, 1 pull-out
141 141 357	U3SA*-X 30/40/45/50/60/80/90/100/120 cm
	XL Pull-out unit 1 pull-out, 1 continuous front, 2 hanging baskets with wooden bottoms
789	UAMD*-X 20/30 cm
	XL Open shelf base unit 2 fixed shelves, side depth: 582 mm
	UR*-X 15/20/30/40/45/50/60 cm

XL Corner base units

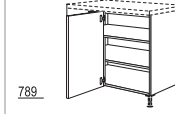
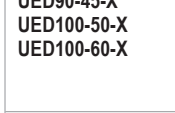
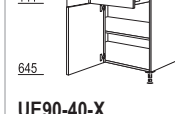
	XL Corner base unit 2 continuous doors, opening angle: 165°, 2 shelves
789	UDTE*-X 80/90 cm
	XL Corner base unit 2 pinned doors, opening angle: 165°, 2 shelves
141 645	UTE*-X 80/90 cm
	XL Corner base unit as carousel unit 2 continuous fronts, Unit height: 822 mm, 1 revolving carousel with 2 wooden shelves and metal railing, rotates 360° height adjustable top shelf
789	UEDK*-X 80/90 cm
	XL Corner base unit as carousel unit 2 pinned fronts, Unit height: 822 mm, 1 revolving carousel with 2 wooden shelves and metal railing, rotates 360° height adjustable top shelf
141 645	UEK*-X 80/90 cm
	XL Chamfered corner base unit 1 continuous door, 2 shelves
789	UED*-X 80/90 cm
	XL Chamfered corner base unit 1 pinned door, 2 shelves
141 645	UE*-X 80/90 cm

XL Half-corner units

	XL Corner base unit 1 continuous door, 2 shelves, 1 angle filler Carcase widths: 900, 1000 mm Planning dimensions: 650 - 750 x ... UED90-40-X...x 1050-1150 mm UED90-45-X...x 1100-1200 mm UED100-50-X...x 1150-1250 mm UED100-60-X...x 1250-1350 mm
789	UED90-40-X UED90-45-X UED100-50-X UED100-60-X
	XL Corner base unit 1 drawer, 1 door, 1 shelf, 1 angle filler Carcase widths: 900, 1000 mm Planning dimensions: 650 - 750 x ... UED90-40-X...x 1050-1150 mm UED90-45-X...x 1100-1200 mm UED100-50-X...x 1150-1250 mm UED100-60-X...x 1250-1350 mm
141 645	UE90-40-X UE90-45-X UE100-50-X UE100-60-X
	XL Corner unit with swivel pull-out 1 continuous door, 2 wooden swivel tablars with metal railing, height adjustable, 1 angle filler Carcase widths: 900, 1000 mm Planning dimensions: 650 - 750 x ... UE*90-45-X...x 1100-1200 mm UE*100-50-X...x 1150-1250 mm UE*100-60-X...x 1250-1350 mm
789	UEDSA90-45-X UEDSA100-50-X UEDSA100-60-X
	XL Corner unit with swivel pull-out 1 drawer, 1 door, 2 wooden swivel tablars with metal railing, height adjustable, 1 angle filler Carcase widths: 900, 1000 mm Planning dimensions: 650 - 750 x ... UE*90-45-X...x 1100-1200 mm UE*100-50-X...x 1150-1250 mm UE*100-60-X...x 1250-1350 mm
141 645	UESA90-45-X UESA100-50-X UESA100-60-X
	XL Corner unit with swivel pull-out 1 pinned door, 2 wooden swivel tablars with metal railing, height adjustable, 1 angle filler Carcase widths: 900, 1000 mm Planning dimensions: 650 - 750 x ... UE*90-45-X...x 1100-1200 mm UE*100-50-X...x 1150-1250 mm UE*100-60-X...x 1250-1350 mm
141 645	UESAV90-45-X UESAV100-50-X UESAV100-60-X
	Surcharge for recessed fillers for fillers and half corner units, side section of carcase material, in carcase height, carcase depth: 561 mm
	MP-GS

Base units in XL height

Carcase depth: 561 mm
 Carcase height: 792 mm
 Plinth height: 70, 100, 150 or 200 mm



XL Angle fillers

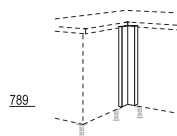

XL Angle filler
 Continuous front material,
 70 x 70 mm, Planning
 dimensions: 650 x 650 mm

UPE-X
 UPE-V-X

as above, however **variable**
 from 50 to 170 mm, Planning
 dimensions: 630 - 750 mm
 1st dimension = left
 2nd dimension = right

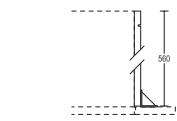

MP-GS

Surcharge for recessed fillers
 for fillers and half corner
 units, side section of
 carcase material,
 in carcase height,
 carcase depth: 561 mm

XL Fillers / Panelling

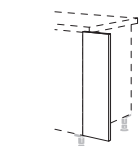

UPK*-X 10/20 cm

XL Filler
 Carcase material,
 792 mm high,
 U-shaped seal for
 connection to wall,
 width: 100/200 mm

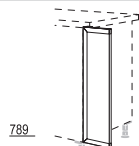

UPD*-X 20 cm

XL Front filler
 Continuous front material,
 width: 200 mm

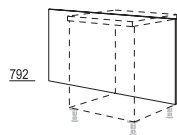

RK-79

XL Base unit back panel
 16 mm thick,
 792 mm high,
 width: 250 - 2000 mm,
 available in all carcase and
 worktop décors from décor
 group 1,
 Vario clip fastening,
 in case of reproduction
 finishes vertical wood grain

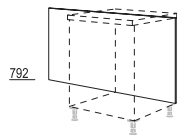

RKS-79

as above, however,
 continuous height,
 including floor profile:
 70 mm plinth height:
 882 mm
 100 mm plinth height:
 912 mm
 150 mm plinth height:
 962 mm
 200 mm plinth height:
 1012 mm

Available floor profile colours:
 010 Black
 014 Stainless steel
 appearance

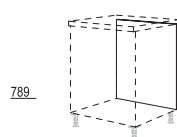

RFD*-79
 30/40/45/50/60 cm

XL Base unit back panel
 1 continuous front,
 789 mm high,
 Vario clip fastening,
 without drill holes

XL Cooker housings



HUB-X 60 cm

XL Cooker housing
 1 fixed panel,
 aperture dimension: 595 mm

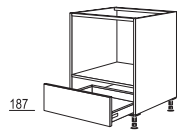

HUS*-X 60 cm

XL Cooker housing
 1 plastic drawer,
 16 l capacity,
 interior dimensions:
 485 x 480 x 68 mm
 aperture dimension: 595 mm

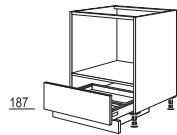

HUG-X 60 cm

XL Cooker housing
 1 large-capacity drawer
 with second level for baking
 trays, plastic, 30 l capacity,
 interior dimensions:
 480 x 380 x 150 mm,
 aperture dimension: 595 mm

XL Hot plate units

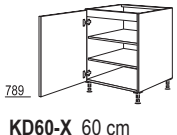

KD60-X 60 cm

XL Hot plate unit
 1 internal panel,
 1 construction shelf for heat
 insulation,
 1 door,
 2 shelves

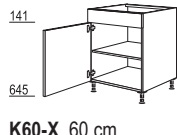

K60-X 60 cm

XL Hot plate unit
 1 fixed panel,
 1 construction shelf for heat
 insulation,
 1 door,
 1 shelf



KS60-X 60 cm

XL Hot plate unit
 1 drawer,
 1 spacer shelf for hot plate,
 1 door,
 1 shelf



KS2A*-X
 60/80/90/100/120 cm

XL Hot plate unit
 1 drawer,
 1 spacer shelf for hot plate,
 2 pull-outs

XL-Doors for integrated appliances

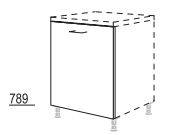

GSBD*-I-X 45/60 cm

Continuous XL door
 for fully integrated
 dishwashers,
 built-under fridge and
 freezer units
 with pull-outs,
 includes spacer strip

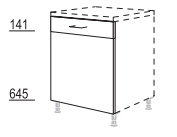

GSB*-I-X 45/60 cm

Pinned XL door
 for fully integrated
 dishwashers,
 built-under fridge and
 freezer units
 with pull-outs,
 includes spacer strip

XL Sink base units

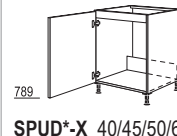

SPUD*-X 40/45/50/60 cm

XL Sink base unit
 1 internal panel,
 1 continuous door

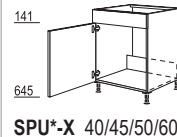

SPU*-X 40/45/50/60 cm

XL Sink base unit
 1 fixed panel,
 1 door

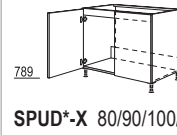

SPUD*-X 80/90/100/120 cm

XL Sink base unit
 2 internal panels,
 2 continuous doors

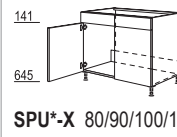

SPU*-X 80/90/100/120 cm

XL Sink base unit
 2 fixed panels,
 2 doors



SPUAD*-X
 40/45/50/60 cm

XL Sink base unit
 1 internal panel,
 1 continuous front with
 centred handle,
 without pull-out rails and
 drill holes

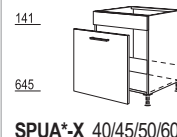

SPUA*-X 40/45/50/60 cm

XL Sink base unit
 1 fixed panel,
 1 front with centred handle,
 without pull-out rails and
 drill holes



SPUDA-ASK*-X
 45/50/60 cm

XL Sink unit Separato-K
 1 internal panel,
 1 pull-out, 500 mm deep, with
waste separation system
Separato-K
 with pull-out lid,
 1 x 18 and 2 x 8 litres,
 500 mm width: with
 1 side organiser,
 600 mm width: with
 2 side organisers,
 1 bio lid (for all widths)



SPUA-ASK*-X
 45/50/60 cm

XL Sink unit Separato-K
 1 fixed panel,
 1 pull-out, 500 mm deep, with
waste separation system
Separato-K
 with pull-out lid,
 1 x 18 and 2 x 8 litres,
 500 mm width: with
 1 side organiser,
 600 mm width: with
 2 side organisers,
 1 bio lid (for all widths)

Worktops | Niche cladding

Worktops

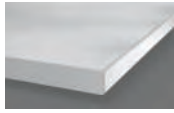

APN
60/70/80/90/100/
110/120 cm

Worktop APN with N-edge
rounded front edge, sides sealed with straight décor edge.
Price per running 100 mm, every 100 mm started will be invoiced.
Maximum 5100 mm wide.
Please quote the décor number in your order.

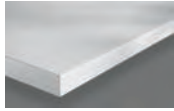

APD
60/70/80/90/100/
110/117 cm

Worktop APD with décor edge
front and side edges coated with straight décor edging material, 1.5 mm thick.
Price per running 100 mm, every 100 mm started will be invoiced.
Maximum 5100 mm wide.
Please quote the décor and edge colour number in your order.

Worktop processing

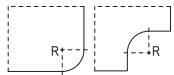

AP-R

Surcharge for exterior and interior roundings deviating from the standard radii on worktops

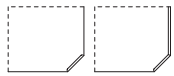

**APN-A
APN-AS
APD-A**

Surcharge for chamfered cuts
on worktops and tables, including edging

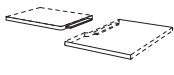

AP-NF

Tongue and groove joint for worktop corners or extensions, incl. screw fittings, tongues and water resistant glue



AP-AUS

Cut-outs for built in hobs, sinks or ventilation grills



AP-IEK

Surcharge for inner corners in square design
on worktops and tables with décor edge

Niche cladding



**NV 52
NV 54
NV 70**

Niche cladding coated on both faces, 16 mm thick, **horizontal structure (except 226 Metal art décor, 273 Carrara marble reproduction, 274 Teramo marble reproduction)** with edge on all sides, width: 250 - 2580 mm **heights:**
NV52 for niches beneath wall units of height 1
NV54 for niches beneath wall units of height 2 and 3
NV70 for niches beneath cooker hoods

Price per started 100 mm.

NV 203

Niche cladding as above, **however with deviating dimensions acc. to sketch** max. 2580 mm wide, 2030 mm high, **1st dimension in direction of grain** coated edge all round.
Minimum price: 0.5 m², minimum dimensions: 250 x 200 mm, **invoiced per m².**

Accessories for niche cladding



NPUK 500

Plastic cover profile in translucent appearance for niche or back panel cladding, 16 mm thick, self-adhesive, 5000 mm long



WAPN
200/400/500 cm

Upstands for continuous planning with niche cladding
2-piece plastic profile with sealing lip, incl. vertical sealing profile dimensions: 25 mm high, 25 mm deep, **delivered as strand material.**

Available in:
014 Stainless steel appearance, 010 Black

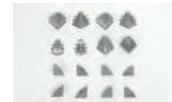

WAPN-Z

WAPN accessory bag matches the plastic upstands WAPN consisting of:
4 x interior corner 90° / 2 x interior corner 135° / 2 x exterior corner 90° / 2 x set of end caps for WAPN / 2 x set of end caps for niche cladding

Available in:
014 Stainless steel appearance, 010 Black



NKPU 200 / 400

Aluminium profile, 2-piece with sealing profile for niche and back panel cladding or as upstand, dimensions: 17 mm high, 20 mm deep

Available in:
014 Stainless steel appearance, 010 Black



NKPO 200 / 400

Niche profile on top aluminium profile, stainless steel appearance for niche cladding incl. 1 set of end caps (left / right), dimensions: 16 mm high, 16 mm deep



NKPU-Z

NKPU accessory bag matches upstand NKPU

Available in:
014 Stainless steel appearance, 010 Black



NKP-EK

1 set of end caps matching aluminium profile for niche cladding NKPO

Upright panels | Top shelves | Wall shelf units

Upright panels for base units

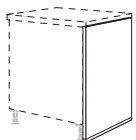

UWA 10/16/25/50 mm

Upright at end of run
incl. floor profile in
014 Stainless steel
appearance or
010 Black,
depth: 583 mm

Plinth height 70 mm: 790 mm
Plinth height 100 mm: 820 mm
Plinth height 150 mm: 870 mm
Plinth height 200 mm: 920 mm

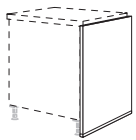

UWR 10/16/25/50 mm

Upright for room designs
depth: 250 to 1166 mm,
edged on both sides,
incl. floor profile in
014 Stainless steel
appearance or
010 Black

Plinth height 70 mm: 790 mm
Plinth height 100 mm: 820 mm
Plinth height 150 mm: 870 mm
Plinth height 200 mm: 920 mm

XL Upright panels for base units

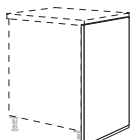

UWA-X 10/16/25/50 mm

XL Upright at end of run
incl. floor seal in
014 Stainless steel
appearance or
010 Black,
depth: 583 mm

Plinth height 70 mm: 862 mm
Plinth height 100 mm: 892 mm
Plinth height 150 mm: 942 mm
Plinth height 200 mm: 992 mm

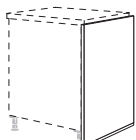

UWR-X 10/16/25/50 mm

XL Upright for room designs
depth: 250 to 1166 mm,
edged on both sides,
incl. floor seal in
014 Stainless steel
appearance or
010 Black

Plinth height 70 mm: 862 mm
Plinth height 100 mm: 892 mm
Plinth height 150 mm: 942 mm
Plinth height 200 mm: 992 mm

Wall shelf units

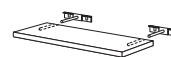

**WB25 30/40/45/50/
60/65/80/90/
100/120 cm**

**Plug-in wall shelf,
25 mm thick**
Carcass material,
polymer edging all around,
255 mm deep,
incl. metal plug fitting



VB16 100 cm

**Wall shelf unit with shelf
holders, 16 mm thick**
255 mm deep,
polymer edging all round,
**available in widths from
250 mm to 1000 mm,**
includes 2 shelf holders
VBH5

VB16 258 cm

Wall shelf unit with shelf
holders as above,
**however available in
widths from 1001 mm to
2580 mm,**
includes 4 shelf holders
VBH5

**Available shelf holder
colours:**
010 Black
014 Stainless steel
appearance

Upright panels for wall units

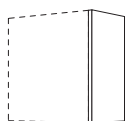

WW 10/16/25/50 mm -1

**Upright at end of run /
intermediate upright for
wall units,
height 1**
depth: 372 mm,
height: 720 mm

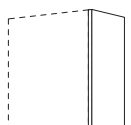

WW 10/16/25/50 mm -2

**Upright at end of run /
intermediate upright for
wall units,
height 2**
depth: 372 mm,
height: 792 mm

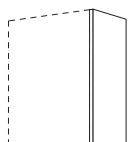

WW 10/16/25/50 mm -3

**Upright at end of run /
intermediate upright for
wall units,
height 3**
depth: 372 mm,
height: 864 mm

Top shelves



ADB10 38/59/117 cm

**Top shelf,
10 mm thick,
for side- or highboard**
coated on both faces,
polymer edged on front
and sides,
length: 250 - 2580 mm



ADB16 38/59/117 cm

**Top shelf,
16 mm thick,
for side- or highboard**
coated on both faces,
polymer edged on front
and sides,
length: 250 - 2580 mm



ADB25 38/59/117 cm

**Top shelf,
25 mm thick,
for side- or highboard**
coated on both faces,
polymer edged on front
and sides,
length: 250 - 2580 mm



ADB50 38/59/117 cm

**Top shelf,
50 mm thick,
for side- or highboard**
coated on both faces,
polymer edged on front
and sides,
length: 250 - 2580 mm

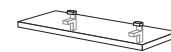

VB25 100 cm

**Wall shelf unit with shelf
holders, 25 mm thick**
255 mm deep,
polymer edging all round,
**available in widths from
250 mm to 1000 mm,**
includes 2 shelf holders
VBH5

VB25 258 cm

Wall shelf unit with shelf
holders as above,
**however available in
widths from 1001 mm to
2580 mm,**
includes 4 shelf holders
VBH5

**Available shelf holder
colours:**
010 Black
014 Stainless steel
appearance

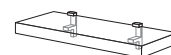

VB50 100 cm

**Wall shelf unit with shelf
holders, 50 mm thick**
255 mm deep,
polymer edging all round,
**available in widths from
250 mm to 1000 mm,**
includes 2 shelf holders
VBH5

VB50 258 cm

Wall shelf unit with shelf
holders as above,
**however available in
widths from 1001 mm to
2580 mm,**
includes 4 shelf holders
VBH5

**Available shelf holder
colours:**
010 Black
014 Stainless steel
appearance

Highboards – 1555 / 1585 / 1635 / 1685 mm high

Carcase depth: 561 mm
 Carcase height: 1485 mm
 Plinth height: 70, 100, 150 oder 200 mm

Highboards

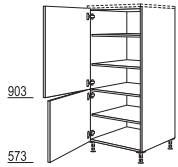

Highboard
 2 doors,
 1 fixed shelf,
 3 shelves

H 30/40/50/60 cm

Housing for ovens

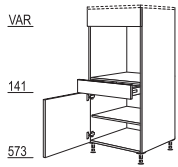

Oven housing
 aperture height: 590 mm
 1 fixed compensation panel,
 1 drawer,
 1 door,
 1 shelf

GOS

Integrated appliance housings with aperture height up to 880 mm

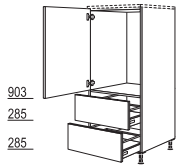

Appliance housing for integrated fridge
 aperture height: 880 mm
 1 appliance door,
 2 pull-outs

G88A

Integrated appliance housings with aperture height up to 1230 mm

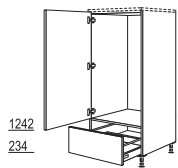

Appliance housing for integrated fridge
 aperture height: 1230 mm
 1 appliance door,
 1 pull-out

G123A

Appliance housings with aperture height up to 1450 mm

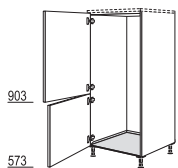

Appliance housing for integrated fridge / freezer
 aperture height: 1450 mm
 for Progress PKG 1453 and
 AEG SCB 614 F1 LS
 2 appliance doors,
 bottom shelf made of 2 mm sheet steel

G145S

Fillers

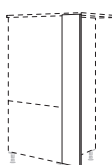

Filler
 Carcase material,
 1485 mm high,
 U-shaped seal for
 connection to wall
 width: 230 mm

HPK 20 cm

XL Highboards – 1654 / 1684 / 1734 / 1784 mm high

Carcase depth: 561 mm
 Carcase height: 1584 mm
 Plinth height: 70, 100, 150 oder 200 mm



XL Highboards

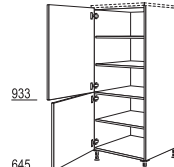

XL Highboard
 2 doors,
 1 fixed shelf,
 3 shelves

H*-X 30/40/50/60 cm

XL Housing for ovens

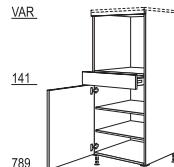

XL Oven housing
 aperture height: 590 mm
 1 fixed compensation panel,
 1 drawer,
 1 door,
 2 shelves

GDOS-X

XL Integrated appliance housings with aperture height up to 880 mm

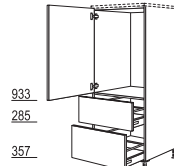

XL Appliance housing for integrated fridge
 aperture height: 880 mm
 1 appliance door,
 2 pull-outs

G88A-X

XL Integrated appliance housings with aperture height up to 1230 mm

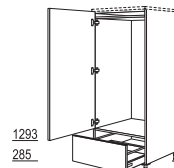

XL Appliance housing for integrated fridge
 aperture height: 1230 mm
 1 appliance door,
 1 pull-out

G123A-X

XL Appliance housings with aperture height up to 1450 mm

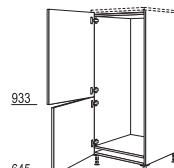

XL Appliance housing for integrated fridge / freezer
 aperture height: 1450 mm
 2 appliance doors

G145-X

XL Fillers

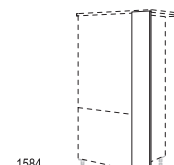

XL Filler
 Carcase material,
 1584 mm high,
 U-shaped seal for
 connection to wall,
 width: 230 mm

HPK20-X 20 cm

Tall units, height 1 – 2067 / 2097 / 2147 / 2197 mm high

Carcase depth: 561 mm
 Carcase height: 1997 mm
 Plinth height: 70, 100, 150 oder 200 mm

Tall units

515
903
573



Pantry unit
 3 doors,
 2 fixed shelves,
 4 shelves

H*-1 30/40/50/60 cm

1277
717



Pantry unit
 2 doors,
 1 fixed shelf,
 4 shelves

HDV*-1 30/40/50/60 cm

515
903
573



Larder unit
 1 pull-out with
 cushioned opening and
 closing SoftStoppPro,
 5 hanging baskets with
 wooden bottoms and
 metal railing, adjustable

HA*-1 30/40 cm

1277
717



Larder unit
 1 pull-out with
 cushioned opening and
 closing SoftStoppPro,
 5 hanging baskets with
 wooden bottoms and
 metal railing, adjustable

HDA*-1 30/40 cm

515
903
573



Broom cupboard
 1 door,
 1 fixed shelf,
 1 shelf,
 1 lug connected door,
 1 system grid,
 2 baskets for cleaning
 materials,
 1 system shelf,
 1 hose rack for vacuum
 cleaner,
 2 pegboards

HB*-1 40/50/60 cm

515
903
573

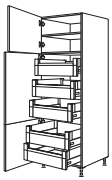

Tall unit
 1 door,
 1 lug connected door,
 5 internal pull-outs,
 1 fixed shelf,
 1 shelf

HI*-1 40/50/60 cm

Appliance housing for ovens, microwaves, steam cookers, compact appliances

675
717



Oven housing
 aperture height: 590 mm
 2 doors,
 2 shelves

GO-1

675
141
573



Oven housing
 aperture height: 590 mm
 1 door,
 1 drawer,
 1 door,
 2 shelves

GOS-1

675
141
285
285

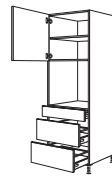

Oven housing
 aperture height: 590 mm
 1 door,
 1 shelf,
 1 drawer,
 2 pull-outs

GOS2A-1

VAR
VAR



**Appliance housing for
 oven and microwave**
 aperture height: variable
 1 door,
 1 shelf,
 2 variable apertures,
 1 pull-out

GMO-1

371
448
573

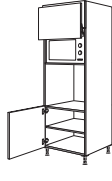

**Appliance housing for
 oven and microwave with
 lifting door**
 aperture height: 370 mm
 aperture height: 590 mm
 1 flap,
 1 lifting door,
 1 door,
 1 shelf

GLO-1

371
448
285
285

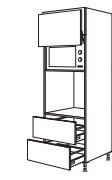

**Appliance housing for
 oven and microwave with
 lifting door**
 aperture height: 370 mm
 aperture height: 590 mm
 1 flap,
 1 lifting door,
 2 pull-outs

GLO2A-1

Appliance housings with aperture height up to 880 mm

515
903
573



**Appliance housing
 for integrated fridge**
 aperture height: 880 mm
 2 doors,
 1 appliance door,
 2 shelves

G88-1

371
903
717



**Appliance housing
 for integrated fridge**
 aperture height: 880 mm
 1 flap,
 1 door,
 1 appliance door,
 1 shelf

GD88-1

515
903
285
285



**Appliance housing
 for integrated fridge**
 aperture height: 880 mm
 1 door,
 1 shelf,
 1 appliance door,
 2 pull-outs

G88A-1

Appliance housings with aperture height up to 1230 mm

1277
717



**Appliance housing
 for integrated fridge**
 aperture height: 1230 mm
 1 appliance door,
 1 door,
 1 shelf

G123-1

515
1242
234



**Appliance housing
 for integrated fridge**
 aperture height: 1230 mm
 1 door,
 1 shelf,
 1 appliance door,
 1 pull-out

G123A-1

515
448
1024

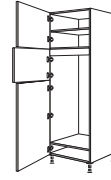

**Appliance housing for
 integrated fridge / freezer**
 aperture height: 1230 mm
 1 door,
 1 shelf,
 1 appliance door for
 freezer compartment,
 1 internal panel,
 1 appliance door for
 fridge section

G123G-1

Tall units, height 1 – 2067 / 2097 / 2147 / 2197 mm high

Carcase depth: 561 mm
 Carcase height: 1997 mm
 Plinth height: 70, 100, 150 oder 200 mm

Appliance housings with aperture height up to 1450 mm

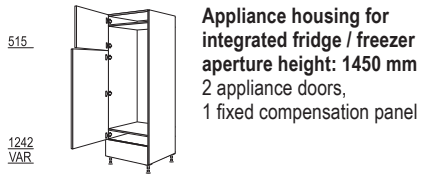

G145B-1

Appliance housing for
integrated fridge / freezer
aperture height: 1450 mm
2 appliance doors,
1 fixed compensation panel

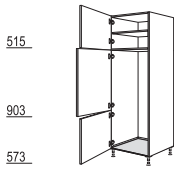

G145S-1

Appliance housing for
integrated fridge / freezer
aperture height: 1450 mm
for Progress PKG 1453
and AEG SCB 614 F1 LS
1 door,
1 shelf,
2 appliance doors,
bottom shelf made of
2 mm thick sheet steel

Fillers / Cladding

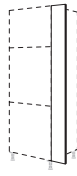

HPK20-1 20 cm

Filler
Carcase material,
1997 mm high,
U-shaped seal for
connection to wall
width: 230 mm

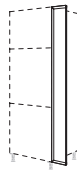

HPD20-1 20 cm

Front filler
Continuous front material,
width: 200 mm

Appliance housings with aperture height between 1580 - 1780 mm

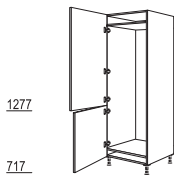

GD178-1

Appliance housing
for fridge / freezer
aperture height: 1780 mm
2 appliance doors



Tall units in XL height, height 1 XL – 2139 / 2169 / 2219 / 2269 mm high

Carcase depth: 561 mm
 Carcase height: 2069 mm
 Plinth height: 70, 100, 150 oder 200 mm



XL Tall units



H*-1X 30/40/50/60 cm



HDV*-1X 30/40/50/60 cm

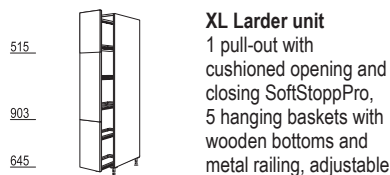

HA*-1X 30/40 cm

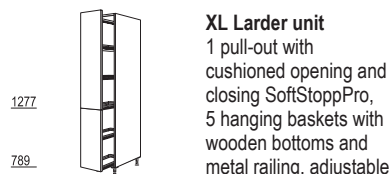

HDA*-1X 30/40 cm

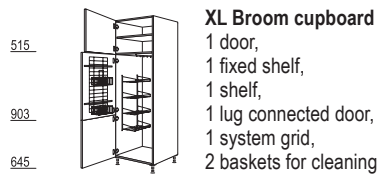

HB*-1X 40/50/60 cm

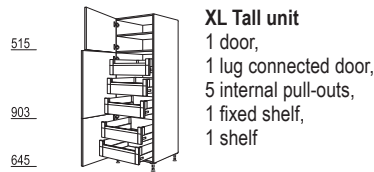

HI*-1X 40/50/60 cm

XL Appliance housing for ovens, micro-waves, steam cookers, compact appliances



GO-1X



GOS-1X

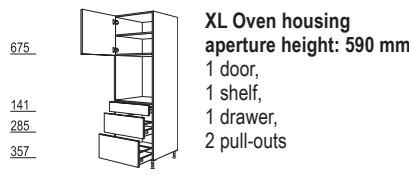

GOS2A-1X

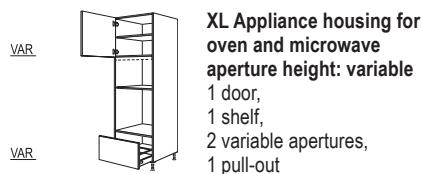

GMO-1X

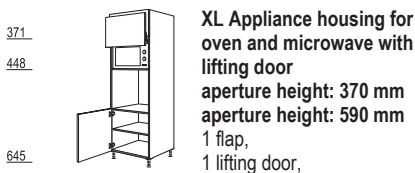

GLO-1X

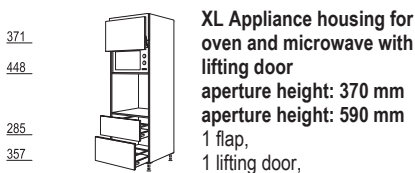

GLO2A-1X

XL Appliance housings with aperture height up to 880 mm



G88-1X

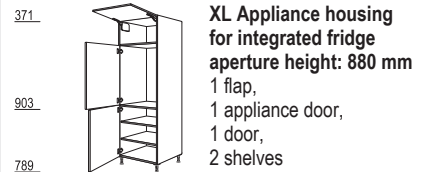

GD88-1X

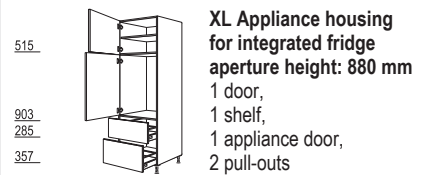

G88A-1X

XL Appliance housings with aperture height up to 1230 mm

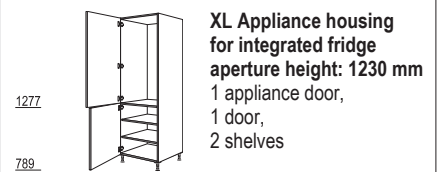

G123-1X

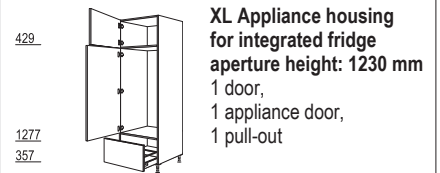

G123A-1X

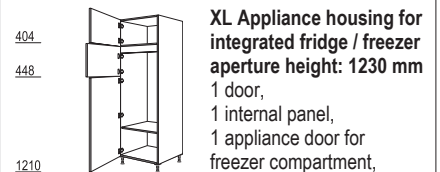

G123G-1X

Tall units in XL height, height 1 XL – 2139 / 2169 / 2219 / 2269 mm high



Carcase depth: 561 mm
 Carcase height: 2069 mm
 Plinth height: 70, 100, 150 oder 200 mm

XL Appliance housings with aperture height up to 1450 mm

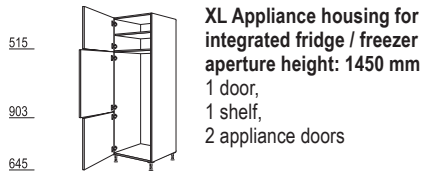

G145-1X

XL Appliance housing for integrated fridge / freezer aperture height: 1450 mm
 1 door,
 1 shelf,
 2 appliance doors

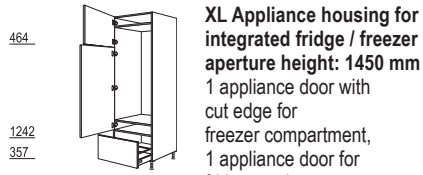

G145A-1X

XL Appliance housing for integrated fridge / freezer aperture height: 1450 mm
 1 appliance door with cut edge for freezer compartment,
 1 appliance door for fridge section,
 1 pull-out

XL Fillers / Cladding

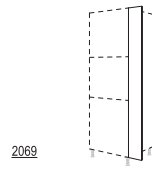

HPK20-1X 20 cm

XL Filler
 Carcase material,
 2069 mm high,
 U-shaped seal for connection to wall
 width: 230 mm

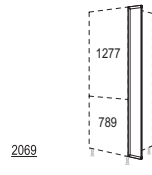

HPD20-1X 20 cm

XL Front filler
 Continuous front material,
 width: 200 mm

XL Appliance housings with aperture height between 1580 - 1780 mm



GD178-1X

XL Appliance housing for fridge / freezer aperture height: 1780 mm
 2 appliance doors



Tall units, height 2 – 2158 / 2188 / 2238 / 2288 mm high

Carcase depth: 561 mm
 Carcase height: 2088 mm
 Plinth height: 70, 100, 150 oder 200 mm

Tall units



Pantry unit
 3 doors,
 2 fixed shelves,
 4 shelves

H*-2 30/40/50/60 cm



Pantry unit
 2 doors,
 1 fixed shelf,
 4 shelves

HDV*-2 30/40/50/60 cm

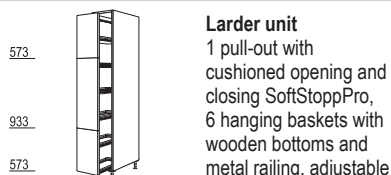

Larder unit
 1 pull-out with
 cushioned opening and
 closing SoftStoppPro,
 6 hanging baskets with
 wooden bottoms and
 metal railing, adjustable

HA*-2 30/40 cm

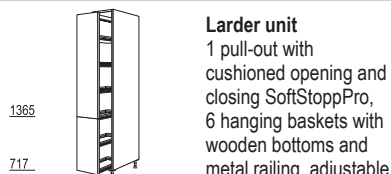

Larder unit
 1 pull-out with
 cushioned opening and
 closing SoftStoppPro,
 6 hanging baskets with
 wooden bottoms and
 metal railing, adjustable

HDA*-2 30/40 cm

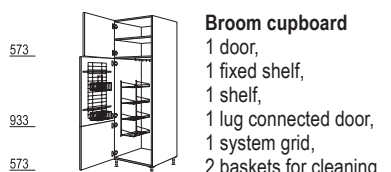

Broom cupboard
 1 door,
 1 fixed shelf,
 1 shelf,
 1 lug connected door,
 1 system grid,
 2 baskets for cleaning
 materials,
 1 system shelf,
 1 hose rack for vacuum
 cleaner,
 2 pegboards

HB*-2 40/50/60 cm

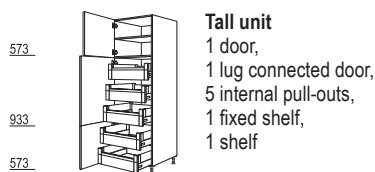

Tall unit
 1 door,
 1 lug connected door,
 5 internal pull-outs,
 1 fixed shelf,
 1 shelf

HI*-2 40/50/60 cm

Appliance housing for ovens, microwaves, steam cookers, compact appliances



Oven housing
 aperture height: 590 mm
 2 doors,
 1 fixed compensation panel,
 2 shelves

GO-2



Oven housing
 aperture height: 590 mm
 2 doors,
 1 fixed compensation panel,
 1 drawer,
 2 shelves

GOS-2



Oven housing
 aperture height: 590 mm
 1 door,
 1 shelf,
 1 fixed compensation panel,
 1 drawer,
 2 pull-outs

GOS2A-2



**Appliance housing for
 oven and microwave**
 aperture height: 380 mm
 aperture height: 590 mm
 1 door,
 1 shelf,
 1 fixed compensation panel,
 1 pull-out

GMO-2



**Appliance housing for
 oven and microwave with
 lifting door**
 aperture height: 370 mm
 aperture height: 590 mm
 2 doors,
 1 lifting door,
 1 fixed compensation panel,
 1 shelf

GLO-2

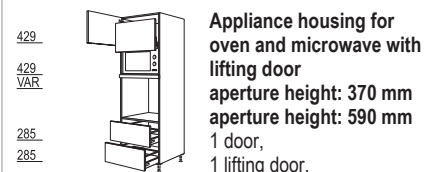

**Appliance housing for
 oven and microwave with
 lifting door**
 aperture height: 370 mm
 aperture height: 590 mm
 1 door,
 1 lifting door,
 1 fixed compensation panel,
 2 pull-outs

GLO2A-2

Appliance housings with aperture height up to 880 mm

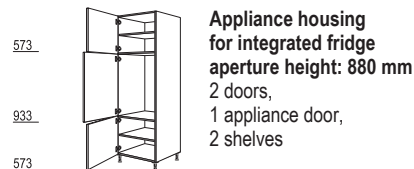

**Appliance housing
 for integrated fridge**
 aperture height: 880 mm
 2 doors,
 1 appliance door,
 2 shelves

G88-2

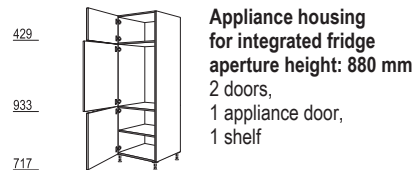

**Appliance housing
 for integrated fridge**
 aperture height: 880 mm
 2 doors,
 1 appliance door,
 1 shelf

GD88-2

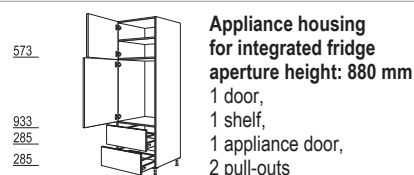

**Appliance housing
 for integrated fridge**
 aperture height: 880 mm
 1 door,
 1 shelf,
 1 appliance door,
 2 pull-outs

G88A-2

Appliance housings with aperture height up to 1230 mm

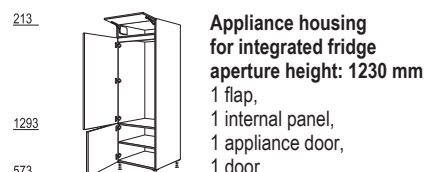

**Appliance housing
 for integrated fridge**
 aperture height: 1230 mm
 1 flap,
 1 internal panel,
 1 appliance door,
 1 door,
 1 shelf

G123-2

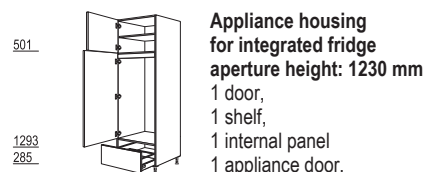

**Appliance housing
 for integrated fridge**
 aperture height: 1230 mm
 1 door,
 1 shelf,
 1 internal panel
 1 appliance door,
 1 pull-out

G123A-2

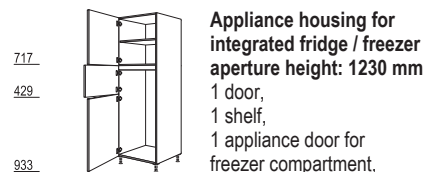

**Appliance housing for
 integrated fridge / freezer**
 aperture height: 1230 mm
 1 door,
 1 shelf,
 1 appliance door for
 freezer compartment,
 1 internal panel,
 1 appliance door for
 fridge section

G123G-2

Tall units, height 2 – 2158 / 2188 / 2238 / 2288 mm high

Carcase depth: 561 mm
 Carcase height: 2088 mm
 Plinth height: 70, 100, 150 oder 200 mm

Appliance housings with aperture height up to 1450 mm

429
933
717



**Appliance housing for fridge / freezer
aperture height: 1450 mm**
 1 door,
 1 internal panel,
 2 appliance doors

GD145-2

573
933
573

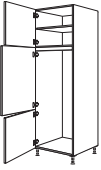

**Appliance housing for integrated fridge / freezer
aperture height: 1450 mm**
 1 door,
 1 shelf,
 1 internal panel,
 2 appliance doors,

G145-2

Fillers / Cladding

2088

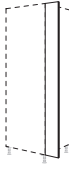

Filler
 Carcase material,
 2088 mm high,
 U-shaped seal for
 connection to wall
 width: 230 mm

HPK20-2 20 cm

1365
717
2085

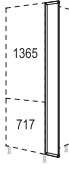

Front filler
 Continuous front material,
 width: 200 mm

HPD20-2 20 cm

Appliance housings with aperture height between 1580 - 1780 mm

213
1149
717

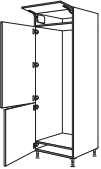

**Appliance housing for fridge / freezer
aperture height: 1780 mm**
 1 flap,
 2 appliance doors

GD178-2



Tall units in XL height, height 2 XL – 2230 / 2260 / 2310 / 2360 mm high

Carcase depth: 561 mm
 Carcase height: 2160 mm
 Plinth height: 70, 100, 150 oder 200 mm



XL Tall units

573
933
645

XL Pantry unit
 3 doors,
 2 fixed shelves,
 4 shelves

H*-2X 30/40/50/60 cm

1365
789

XL Pantry unit
 2 doors,
 1 fixed shelf,
 5 shelves

HDV*-2X 30/40/50/60 cm

573
933
645

XL Larder unit
 1 pull-out with
 cushioned opening and
 closing SoftStoppPro,
 6 hanging baskets with
 wooden bottoms and
 metal railing, adjustable

HA*-2X 30/40 cm

1365
789

XL Larder unit
 1 pull-out with
 cushioned opening and
 closing SoftStoppPro,
 6 hanging baskets with
 wooden bottoms and
 metal railing, adjustable

HDA*-2X 30/40 cm

573
933
645

XL Broom cupboard
 1 door,
 1 fixed shelf,
 1 shelf,
 1 lug connected door,
 1 system grid,
 2 baskets for cleaning
 materials,
 1 system shelf,
 1 hose rack for vacuum
 cleaner,
 2 pegboards

HB*-2X 40/50/60 cm

573
933
645

XL Tall unit
 1 door,
 1 lug connected door,
 5 internal pull-outs,
 1 fixed shelf,
 1 shelf

HI*-2X 40/50/60 cm

XL Appliance housing for ovens, micro-waves, steam cookers, compact appliances

717
VAR
789

XL Oven housing
 aperture height: 590 mm
 2 doors,
 1 fixed compensation panel,
 3 shelves

GO-2X

717
VAR
141
645

XL Oven housing
 aperture height: 590 mm
 2 doors,
 1 fixed compensation panel,
 1 drawer,
 2 shelves

GOS-2X

717
VAR
141
285
357

XL Oven housing
 aperture height: 590 mm
 1 door,
 1 shelf,
 1 fixed compensation panel,
 1 drawer,
 2 pull-outs

GOS2A-2X

429
VAR
285
357

XL Appliance housing
 for oven and microwave
 aperture height: 380 mm
 aperture height: 590 mm
 1 door,
 1 fixed compensation panel,
 2 pull-outs

GMO2A-2X

429
VAR
645

XL Appliance housing
 for oven and microwave
 with
 lifting door
 aperture height: 370 mm
 aperture height: 590 mm
 2 doors,
 1 lifting door,
 1 fixed compensation panel,
 1 shelf

GLO-2X

429
VAR
285
357

XL Appliance housing
 for oven and microwave
 with
 lifting door
 aperture height: 370 mm
 aperture height: 590 mm
 1 door,
 1 lifting door,
 1 fixed compensation panel,
 2 pull-outs

GLO2A-2X

XL Appliance housings with aperture height up to 880 mm

573
933
645

XL Appliance housing
 for integrated fridge
 aperture height: 880 mm
 2 doors,
 1 appliance door,
 2 shelves

G88-2X

429
933
789

XL Appliance housing
 for integrated fridge
 aperture height: 880 mm
 2 doors,
 1 appliance door,
 2 shelves

GD88-2X

573
933
285
357

XL Appliance housing
 for integrated fridge
 aperture height: 880 mm
 1 door,
 1 shelf,
 1 appliance door,
 2 pull-outs

G88A-2X

XL Appliance housings with aperture height up to 1230 mm

213
1293
645

XL Appliance housing
 for integrated fridge
 aperture height: 1230 mm
 1 flap,
 1 internal panel,
 1 appliance door,
 1 door,
 1 shelf

G123-2X

501
1293
357

XL Appliance housing
 for integrated fridge
 aperture height: 1230 mm
 1 door,
 1 shelf,
 1 internal panel
 1 appliance door,
 1 pull-out

G123A-2X

717
429
1005

XL Appliance housing
 for integrated fridge / freezer
 aperture height: 1230 mm
 1 door,
 1 shelf,
 1 appliance door for
 freezer compartment,
 1 internal panel,
 1 appliance door for
 fridge section

G123G-2X

Tall units in XL height, height 2 XL – 2230 / 2260 / 2310 / 2360 mm high

Carcase depth: 561 mm
Carcase height: 2160 mm
Plinth height: 70, 100, 150 oder 200 mm



XL Appliance housings with aperture height up to 1450 mm

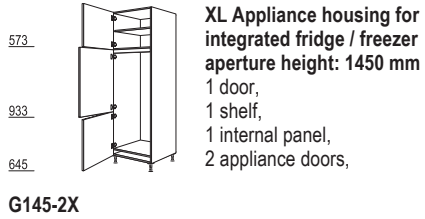

XL Fillers / Cladding

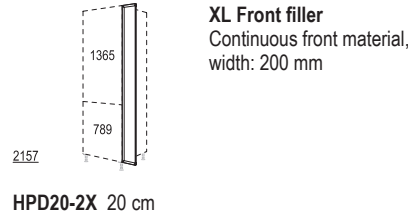
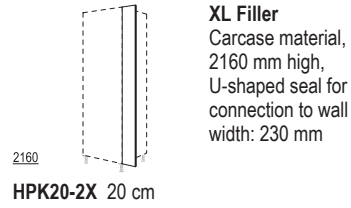

XL Appliance housings with aperture height between 1580 - 1780 mm

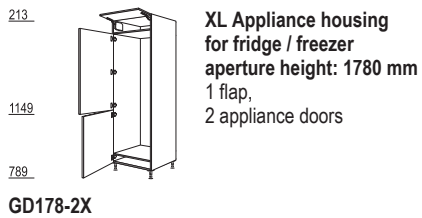

Tall units, height 3 – 2230 / 2260 / 2310 / 2360 mm high

Carcase depth: 561 mm
 Carcase height: 2160 mm
 Plinth height: 70, 100, 150 oder 200 mm

Tall units



Pantry unit
 3 doors,
 2 fixed shelves,
 4 shelves

645
 933
 573

H*-3 30/40/50/60 cm



Pantry unit
 2 doors,
 1 fixed shelf,
 4 shelves

1437
 717

HDV*-3 30/40/50/60 cm



Larder unit
 1 pull-out with
 cushioned opening and
 closing SoftStoppPro,
 6 hanging baskets with
 wooden bottoms and
 metal railing, adjustable

645
 933
 573

HA*-3 30/40 cm



Larder unit
 1 pull-out with
 cushioned opening and
 closing SoftStoppPro,
 6 hanging baskets with
 wooden bottoms and
 metal railing, adjustable

1437
 717

HDA*-3 30/40 cm



Broom cupboard
 1 door,
 1 fixed shelf,
 1 shelf,
 1 lug connected door,
 1 system grid,
 2 baskets for cleaning
 materials,
 1 system shelf,
 1 hose rack for vacuum
 cleaner,
 2 pegboards

645
 933
 573

HB*-3 40/50/60 cm

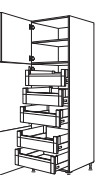

Tall unit
 1 door,
 1 lug connected door,
 5 internal pull-outs,
 1 fixed shelf,
 1 shelf

645
 933
 573

HI*-3 40/50/60 cm

Appliance housing for ovens, micro-waves, steam cookers, compact appliances



Oven housing
 aperture height: 590 mm
 2 doors,
 1 fixed compensation panel,
 3 shelves

789
 VAR

717

GO-3



Oven housing
 aperture height: 590 mm
 2 doors,
 1 fixed compensation panel,
 1 drawer,
 3 shelves

789
 VAR

141
 573

GOS-3

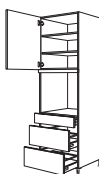

Oven housing
 aperture height: 590 mm
 1 door,
 2 shelves,
 1 fixed compensation panel,
 1 drawer,
 2 pull-outs

789
 VAR

141
 285
 285

GOS2A-3



Appliance housing
 for oven and microwave
 aperture height: 380 mm
 aperture height: 590 mm
 1 door,
 1 shelf,
 1 fixed compensation panel,
 1 pull-out

717
 VAR

357

GMO-3



Appliance housing for
 oven and microwave
 with
 lifting door
 aperture height: 370 mm
 aperture height: 590 mm
 2 doors,
 1 lifting door,
 1 fixed compensation panel,
 2 shelves

501
 429
 VAR

573

GLO-3

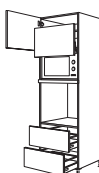

Appliance housing for
 oven and microwave
 with
 lifting door
 aperture height: 370 mm
 aperture height: 590 mm
 1 door,
 1 shelf,
 1 lifting door,
 1 fixed compensation panel,
 2 pull-outs

501
 429
 VAR

285
 285

GLO2A-3

Appliance housings with aperture height up to 880 mm



Appliance housing
 for integrated fridge
 aperture height: 880 mm
 2 doors,
 1 appliance door,
 2 shelves

645
 933
 573

G88-3



Appliance housing
 for integrated fridge
 aperture height: 880 mm
 2 doors,
 1 appliance door,
 2 shelves

501
 933
 717

GD88-3



Appliance housing
 for integrated fridge
 aperture height: 880 mm
 1 door,
 1 shelf,
 1 appliance door,
 2 pull-outs

645
 933
 285
 285

G88A-3

Appliance housings with aperture height up to 1230 mm



Appliance housing
 for integrated fridge
 aperture height: 1230 mm
 1 flap,
 1 internal panel,
 1 appliance door,
 1 door,
 1 shelf

285
 1293
 573

G123-3



Appliance housing
 for integrated fridge
 aperture height: 1230 mm
 1 door,
 1 shelf,
 1 internal panel
 1 appliance door,
 1 pull-out

573
 1293
 285

G123A-3

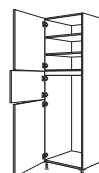

Appliance housing for
 integrated fridge / freezer
 aperture height: 1230 mm
 1 door,
 2 shelves,
 1 appliance door for
 freezer compartment,
 1 internal panel,
 1 appliance door for
 fridge section

789
 429
 933

G123G-3

Tall units, height 3 – 2230 / 2260 / 2310 / 2360 mm high

Carcase depth: 561 mm
 Carcase height: 2160 mm
 Plinth height: 70, 100, 150 oder 200 mm

Appliance housings with aperture height up to 1450 mm

501
933
717
GD145-3



Appliance housing for fridge / freezer aperture height: 1450 mm
 1 door,
 1 internal panel,
 1 shelf,
 2 appliance doors

645
933
573
G145-3

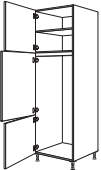

Appliance housing for integrated fridge / freezer aperture height: 1450 mm
 1 door,
 1 shelf,
 1 internal panel,
 2 appliance doors,

Fillers / Cladding

2160
HPK20-3 20 cm

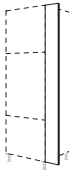

Filler
 Carcase material,
 2160 mm high,
 U-shaped seal for
 connection to wall
 width: 230 mm

1437
717
2157
HPD20-3 20 cm

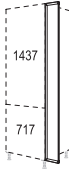

Front filler
 Continuous front material,
 width: 200 mm

Appliance housings with aperture height between 1580 - 1780 mm

285
1149
717
GD178-3

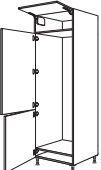

Appliance housing for fridge / freezer aperture height: 1780 mm
 1 flap,
 2 appliance doors



Wall units, 360 mm high

Carcase depth: 350 mm
Carcase height: 360 mm

Wall units 360 mm high

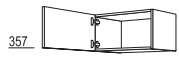

Wall unit
1 door

W*-36
45/50/60 cm

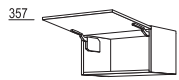

Wall unit with flap door
1 flap,
opening angle 107°

WK*-36
45/50/60/80/90/100/
120 cm

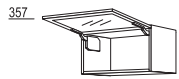

Wall unit with framed glass flap door
1 framed glass flap door,
clear glass No. 01,
opening angle 107°,
glass variants against
surcharge: no. 02 / 39

WKG*-36
50/60/80/90/100/
120 cm

No image

Surcharge for different glass choice
for glass variants:
No. 02 Matt glass
No. 39 Black glass

MP-GW

Wall units 360 mm high

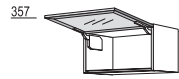

Wall unit with glass doors
Square

1 aluminium framed flap,
opening angle 107°,
handleless version with wall
unit bottom shelf with
attached profile strip in
stainless steel appearance

WKSQ*-36
50/60/80/90/100/
120 cm

Available in:
No. 321 Aluminium framed
front in stainless steel
appearance with
02 Matt glass
No. 308 Aluminium framed
front in stainless steel
appearance with
035 Grey glass
No. 329 Aluminium framed
front in Black with
39 Black glass

Fillers

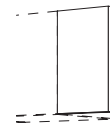

Filler
Carcase material,
360 mm high,
U-shaped seal for
connection to wall
width: 100/200 mm

WPK*-36
10/20 cm

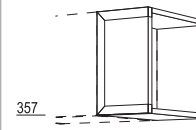

Front filler
Continuous front material,
2 shelves top and bottom,
1 wall unit side panel:
350 mm deep,
width: 200 mm

WPD20-36
20 cm



Wall units, height 1 – 720 mm high

Carcase depth: 350 mm
Carcase height: 720 mm

Wall units 720 mm high

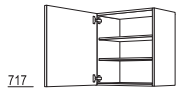

Wall unit
1 door,
2 shelf

W*-1
20/25/30/35/40/45/50/55/60 cm



Wall unit
2 doors,
2 shelves

W2T-1 60 cm
W*-1 80/90/100 cm

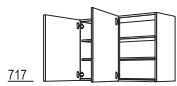

Wall unit
2 doors hinged
parallel,
2 shelves

W2TP*-1
80/90/100 cm



Wall unit
1 folding door with slide
mechanism,
2 shelves

WFT60-1
60 cm

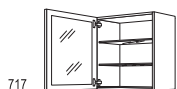

**Wall unit,
framed glass door**
1 door,
clear glass No. 01,
2 glass shelves,
glass variants against
surcharge: no. 02 / 39

WG*-1
45/50/60 cm

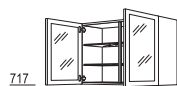

**Wall unit,
framed glass doors**
2 doors,
clear glass No. 01,
2 glass shelves,
glass variants against
surcharge: no. 02 / 39

WG*-1
90/100 cm

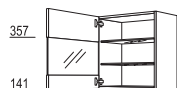

**Wall unit,
segmented glass door**
1 door,
clear glass No. 01,
2 glass shelves,
glass variants against
surcharge: no. 02 / 39

WGLS*-1
45/50/60 cm

Wall units 720 mm high



**Wall unit, segmented
glass doors**
2 doors,
clear glass No. 01,
2 glass shelves,
glass variants against
surcharge: no. 02 / 39

WGLS-1
90/100 cm

No image

**Surcharge for different
glass choice**
for glass variants:
No. 02 Matt glass
No. 39 Black glass

MP-GW

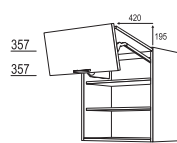

**Wall unit, folding/lifting
door**
1 folding/lifting door,
2 original fronts,
2 shelves

WFL*-1
50/60/80/90/100/120 cm

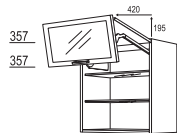

Wall unit, folding/lifting door
1 folding/lifting door,
1 top original front,
1 bottom framed glass front,
clear glass No. 01,
2 glass shelves,
glass variants against
surcharge: no. 02 / 39

WFLG*-1
50/60/80/90/100/120 cm

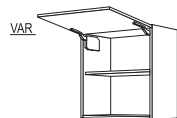

Wall unit for microwave
1 aperture depending
on appliance height,
1 flap as niche
compensation

WM*-1
50/60 cm

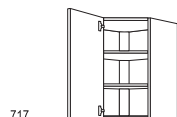

**Corner wall unit,
diagonal**
1 door: 394 mm wide,
opening angle 90°,
2 shelves
Planning dimensions:
650 x 650 mm

WED65-1

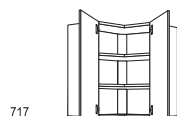

Corner wall unit
2 doors
with 165° hinges,
2 shelves,
hinged side = first
door to be opened

WE*-1
60/65/80/90 cm

Wall units 720 mm high

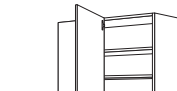

Corner wall unit
1 door,
1 angle filler,
2 shelves

WE60-20-1
WE80-35-1
WE90-45-1

Carcase widths:
600 mm - door width: 194 mm
782 mm - door width: 344 mm
882 mm - door width: 444 mm

Planning dimensions:
WE60-20: **450 x 650 mm**,
variable between
390 - 500 x 630 - 700 mm
WE80-35: **450 x 800 mm**,
variable between
390 - 500 x 790 - 850 mm
WE90-45: **450 x 900 mm**,
variable between
390 - 500 x 890 - 950 mm



Open shelf wall unit
2 fixed shelves,
side depth: 371 mm

WR*-1
15/20/30/40/45/50/60 cm



Wall unit as bottle rack
4 fixed shelves,
side depth: 371 mm

WR15-1
15 cm

Fillers



Filler
Carcass material,
720 mm high,
U-shaped seal for
connection to wall

WPK*-1
10/20 cm

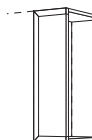

Front filler
Continuous front material,
2 shelves top and bottom,
1 wall unit side panel:
350 mm deep,
width: 200 mm

WPD20-1
20 cm

Wall units, height 2 – 792 mm high

Carcase depth: 350 mm
Carcase height: 792 mm

Wall units 792 mm high



Wall unit
1 door,
2 shelves
W*-2 20/25/30/35/40/45/50/55/60 cm

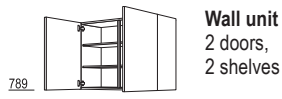

W2T*-2 60 cm
W*-2 80/90/100 cm



W2TP*-2
80/90/100 cm

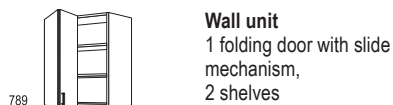

WFT60-2
60 cm

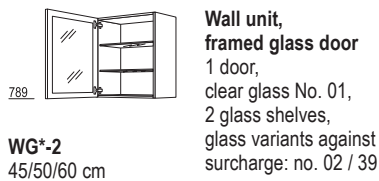

WG*-2
45/50/60 cm

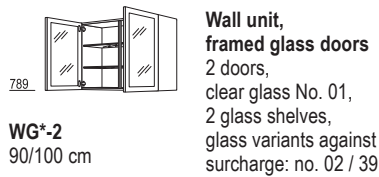

WG*-2
90/100 cm

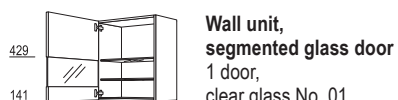

WGLS*-2
45/50/60 cm



WGLS*-2
90/100 cm

No image
MP-GW
Surcharge for different glass choice
for glass variants:
No. 02 Matt glass
No. 39 Black glass

Wall units 792 mm high

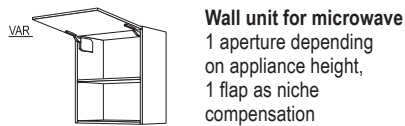

WM*-2
50/60 cm

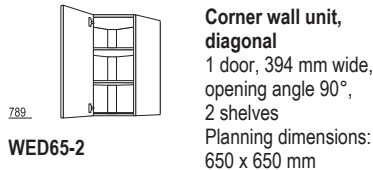

WED65-2

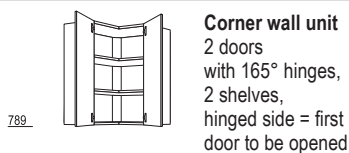

WE*-2
60/65/80/90 cm

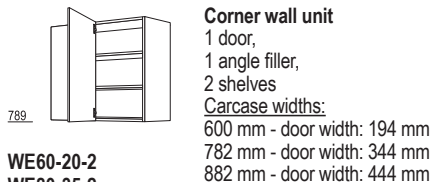

WE60-20-2
WE80-35-2
WE90-45-2

Required floor space /
Planning dimensions:
NWE60-20: **450 x 650 mm**,
variable between
390 - 500 x 630 - 700 mm
NWE90-45: **450 x 900 mm**,
variable between
390 - 500 x 890 - 950 mm

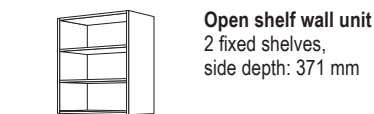

WR*-2
15/20/30/40/45/50/60 cm

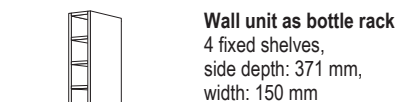

WRF15-2
15 cm

Wall units 792 mm high

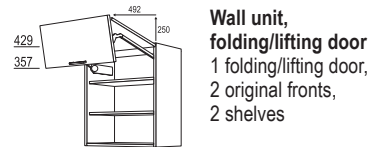

WFL*-2
50/60/80/90/100/120 cm

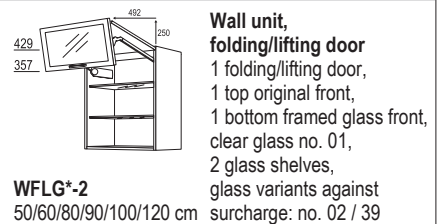

WFLG*-2
50/60/80/90/100/120 cm

Fillers

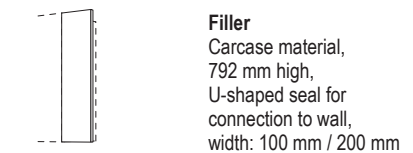

WPK*-2
10/20 cm

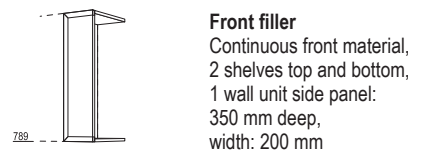

WPD20-2
20 cm

Wall units, height 3 – 864 mm high

Carcase depth: 350 mm
Carcase height: 864 mm

Wall units 864 mm high



861 **Wall unit**
1 door,
2 shelves
W*3 20/25/30/35/40/45/50/55/60 cm

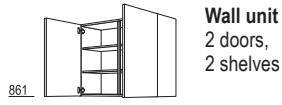

861 **Wall unit**
2 doors,
2 shelves
W2T*3 60 cm
W*3 80/90/100 cm



861 **Wall unit**
2 doors hinged
parallel,
2 shelves
W2TP*3
80/90/100 cm

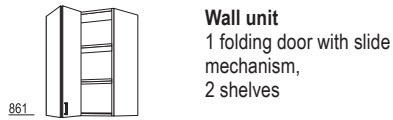

861 **Wall unit**
1 folding door with slide
mechanism,
2 shelves
WFT60-3
60 cm

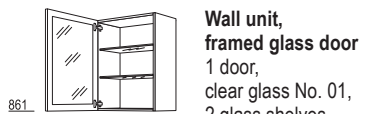

861 **Wall unit,
framed glass door**
1 door,
clear glass No. 01,
2 glass shelves,
glass variants against
surcharge: no. 02 / 39
WG*3
45/50/60 cm



861 **Wall unit,
framed glass doors**
2 doors,
clear glass No. 01,
2 glass shelves,
glass variants against
surcharge: no. 02 / 39
WG*3
90/100 cm

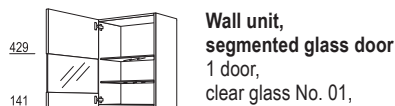

429 861 **Wall unit,
segmented glass door**
1 door,
clear glass No. 01,
2 glass shelves,
glass variants against
surcharge: no. 02 / 39
WGLS*3
45/50/60 cm

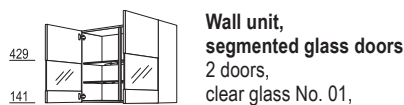

429 861 **Wall unit,
segmented glass doors**
2 doors,
clear glass No. 01,
2 glass shelves,
glass variants against
surcharge: no. 02 / 39
WGLS*3
90/100 cm

No image **Surcharge for different
glass choice**
for glass variants:
No. 02 Matt glass
No. 39 Black glass
MP-GW

Wall units 864 mm high

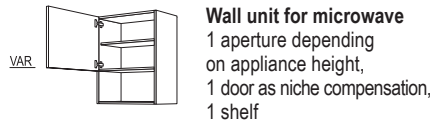

VAR **Wall unit for microwave**
1 aperture depending
on appliance height,
1 door as niche compensation,
1 shelf
WM*3
50/60 cm

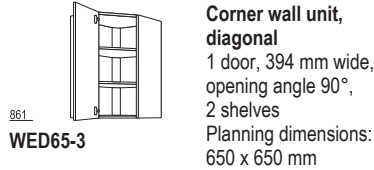

861 **Corner wall unit,
diagonal**
1 door, 394 mm wide,
opening angle 90°,
2 shelves
Planning dimensions:
650 x 650 mm
WED65-3

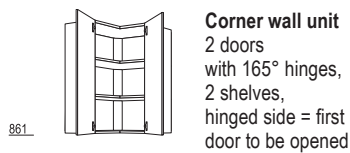

861 **Corner wall unit**
2 doors
with 165° hinges,
2 shelves,
hinged side = first
door to be opened
WE*3
60/65/80/90 cm

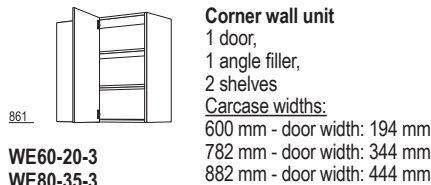

861 **Corner wall unit**
1 door,
1 angle filler,
2 shelves
Carcase widths:
600 mm - door width: 194 mm
782 mm - door width: 344 mm
882 mm - door width: 444 mm
**Required floor space /
Planning dimensions:**
NWE60-20: 450 x 650 mm,
variable between
390 - 500 x 630 - 700 mm
NWE90-45: 450 x 900 mm,
variable between
390 - 500 x 890 - 950 mm

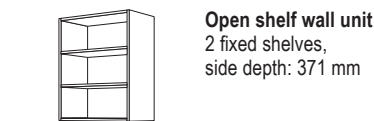

Open shelf wall unit
2 fixed shelves,
side depth: 371 mm
WR*3
15/20/30/40/45/50/60 cm

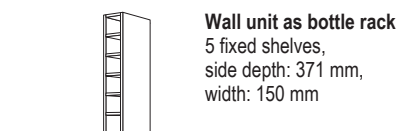

Wall unit as bottle rack
5 fixed shelves,
side depth: 371 mm,
width: 150 mm
WRF15-3
15 cm

Wall units for cooker hoods

Wall units for cooker hoods

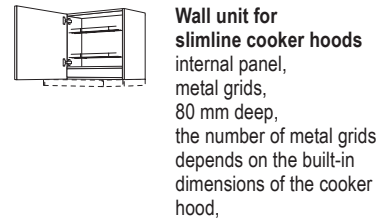

**Wall unit for
slimline cooker hoods**
internal panel,
metal grids,
80 mm deep,
the number of metal grids
depends on the built-in
dimensions of the cooker
hood,
WDAF60-57 60 cm height: 576 mm

WDAF60-1 60 cm height: 720 mm

WDAF60-2 60 cm height: 792 mm

WDAF60-3 60 cm height: 864 mm

Bridging shelf

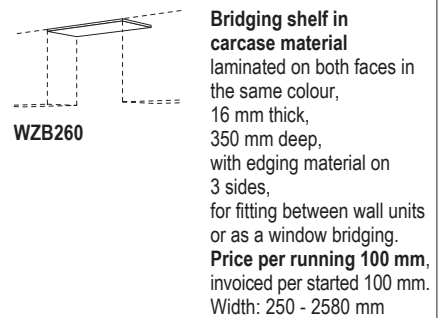

**Bridging shelf in
carcase material**
laminated on both faces in
the same colour,
16 mm thick,
350 mm deep,
with edging material on
3 sides,
for fitting between wall units
or as a window bridging.
Price per running 100 mm,
invoiced per started 100 mm.
Width: 250 - 2580 mm
WZB260

WZB60 Bridging shelf in carcase
material as above,
however 600 mm wide

Fillers

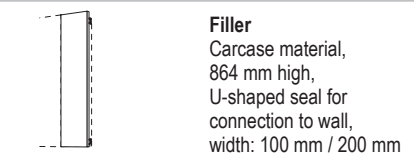

Filler
Carcase material,
864 mm high,
U-shaped seal for
connection to wall,
width: 100 mm / 200 mm
WPK*3
10/20 cm

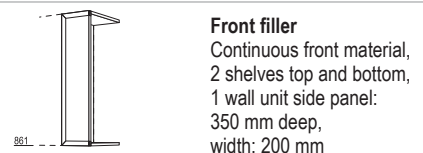

Front filler
Continuous front material,
2 shelves top and bottom,
1 wall unit side panel:
350 mm deep,
width: 200 mm
861 **WPD20-3**
20 cm

Plastic cutlery trays and pull-out organisers



Cutlery tray Trend
grey, height: 43 mm,
fits drawer depth of 500 mm,
side depth 561 mm

BE*
30/40/45/50/60/80/
90/100/120 cm

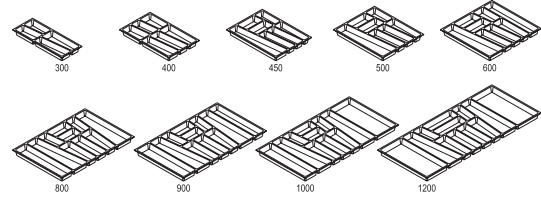

BE* -46
45/50/60/80/90/
100/120 cm

as above, however for drawer depth 400 mm,
side depth 461 mm

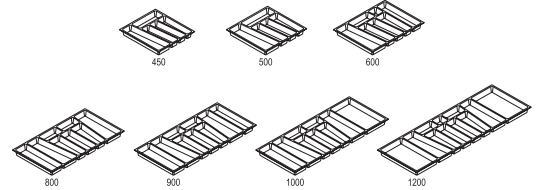

Cutlery tray Move
silver-grey, with dividers for customisable divisions,
height: 47 mm,
fits drawer depth of 500 mm,
side depth 561 mm

BE* M
30/40/45/50/60/80/
90/100/120 cm

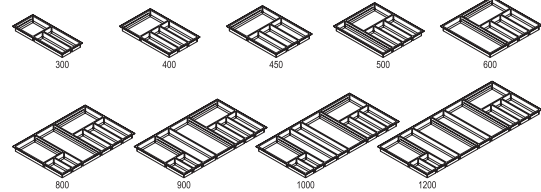

BE* -46 M
45/50/60/80/90/
100/120 cm

as above, however for drawer depth 400 mm,
side depth 461 mm

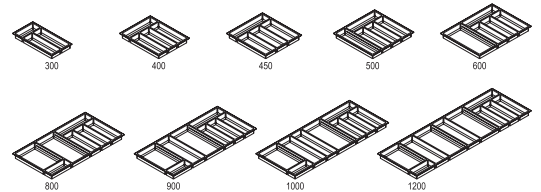

Universal organiser
Alu profile with 4 dividers for individualised divisions, height: 125 mm, fits pull-out depth of 500 mm,
side depth: 561 mm,
1 alu profile of 600 mm width,
2 alu profiles of 800 up to 900 mm width,
3 alu profiles of 1000 up to 1200 mm width

AUO 56

Please order the correct number for the unit width!

AUO 46

as above, however for drawer depth 400 mm,
side depth 461 mm



Cutlery tray Concept
Non-slip soft touch surface,
anthracite, height: 52 mm, fits drawer depth of 500 mm,
side depth: 561 mm

BE* C
30/40/45/50/60/80/
90/100/120 cm

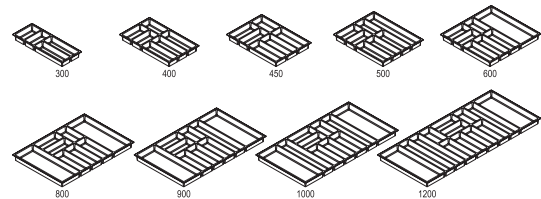

Pull-out organisation concept
Non-slip soft touch surface,
anthracite, height: 100 mm, fits pull-out depth of 500 mm,
side depth: 561 mm

AO* C
60/80/90/100/120 cm

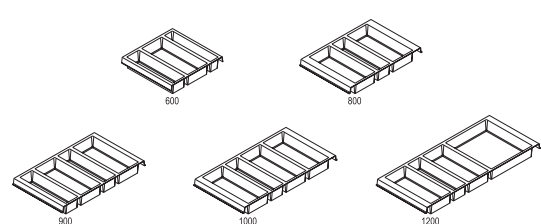

Accessories

Beech cutlery trays and pull-out organisers



Beech wood cutlery tray

solid beech wood,
height: 56 mm, fits drawer depth of 500 mm,
side depth 561 mm

BE* H

30/40/45/50/60/80/
90/100/120 cm

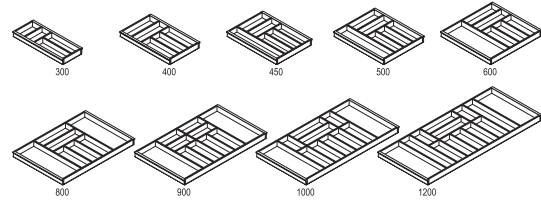

Beech wood universal organiser

with solid wood partitions for individualised divisions,
fits pull-out depth 500 mm,
side depth 561 mm,
incl. 7 solid wood partitions in beech for 600 mm width,
incl. 10 solid wood partitions in beech for 800 / 900 / 1000 mm width,
incl. 13 solid wood partitions in beech for 1200 mm width

AOS* H

60/80/90/100/120 cm

Oak cutlery trays and pull-out organisers



Oak wooden segment cutlery tray

solid wood design in oak,
with anti-slip mat in anthracite,
height: 55 mm, segment width: 274 mm,
fits drawer depth of 500 mm,
side depth: 561 mm,
one wooden segment is delivered up to a width of 600 mm,
for widths exceeding 800 mm, two wooden segments are delivered

BEHS*E

40/45/50/60/80/90/
100/120 cm

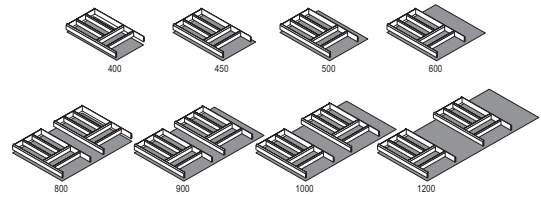

Universal organiser, oak

with solid wood partitions for individualised divisions,
fits pull-out depth 500 mm,
side depth: 561 mm,
incl. 7 solid wood partitions in oak for 600 mm width,
incl. 10 solid wood partitions in oak for 800 / 900 / 1000 mm width,
incl. 13 solid wood partitions in oak for 1200 mm width

AOS* E

60/80/90/100/120 cm



Accessories

Mounting sets



MONSET 1

Mounting set 1

consisting of:

- 1 ball siphon 1 1/2" with 40 mm drain white
- 1 space-saving connector white
- 1 HT bend DN 40/87 grey
- 1 HT tube DN 40 x 250 mm grey
- 1 HT transition element DN 40/50 mm grey
- 1 cooker connection cable, 5 x 2.5 mm², 2000 mm long
- 2 flex hoses acc. to KTW-A, 300 mm long, 3/8" x 10 mm with union nut



MONSET 2

Mounting set 2

consisting of:

- 1 ball siphon 1 1/2" with 40 mm drain white
- 1 space-saving connector white
- 1 HT bend DN 40/87 grey
- 1 HT tube DN 40 x 250 mm grey
- 1 HT transition element DN 40/50 mm grey
- 1 cooker connection cable, 5 x 2.5 mm², 2000 mm long
- 2 flex hoses acc. to KTW-A, 300 mm long, 3/8" x 10 mm with union nut
- 1 hose clip, 16 - 25mm
- 1 table socket, triple, sockets - model F, with contact protection, white with 1500 mm supply line, 3 x 1.5 mm²

Accessories for sink units

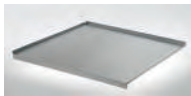

FB*

40/45/50/60/80/90/
100/120 cm

Moisture protection sheet

aluminium sheet, serrated, for sink base units, cannot be used with front pull-outs, fits only for a side depth of 561 mm

FB90: also fits corner sink units SPUE(D)90-45(-X) and NSPUE90-45(-X)

FB100: also fits corner sink units SPUE(D)100-50(-X) and NSPUE100-50(-X)



WSMS*

40/45/50/60/80/90/
100/120 cm

Waterproof mat

plastic, slate grey, for sink base units, not for use with front pull-outs, fits only side depth of 561 mm

Not possible in conjunction with hose and cable feed-through SKD or with opening support mechanism Libero AOUL.

Upstands



WAP

200/400/500 cm

Plastic upstand

Top section with sealing lips, dimensions: 25 mm high, 25 mm deep, **delivered as strand material.**

Available in all worktop décors,

also available in:

No. 014 Stainless steel appearance



WAP-Z

WAP accessory bag

matches the plastic upstands WAPN

consisting of:

- 4 x interior corner 90°
- 2 x interior corner 135°
- 2 x exterior corner 90°
- 2 x set of end caps



WAPN

200/400/500 cm

Upstands for continuous planning with niche cladding

2-piece plastic profile with sealing lip, incl. vertical sealing profile, dimensions: 25 mm high, 25 mm deep, **delivered as strand material.**

Available in:

014 Stainless steel appearance, 010 Black

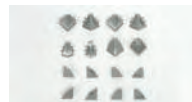

WAPN-Z

WAP accessory bag

matches the plastic upstands WAPN

consisting of:

- 4 x interior corner 90° / 2 x interior corner 135°
- 2 x exterior corner 90°
- 2 x set of end caps for WAPN
- 2 x set of end caps for niche cladding

Available in:

014 Stainless steel appearance, 010 Black

Height grid, carcase heights

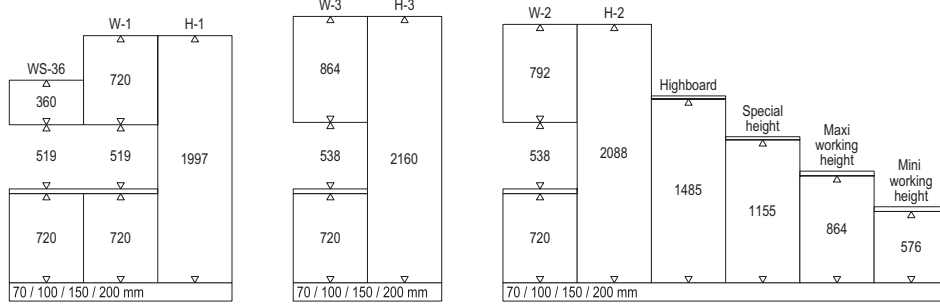

Height grid, XL carcase heights

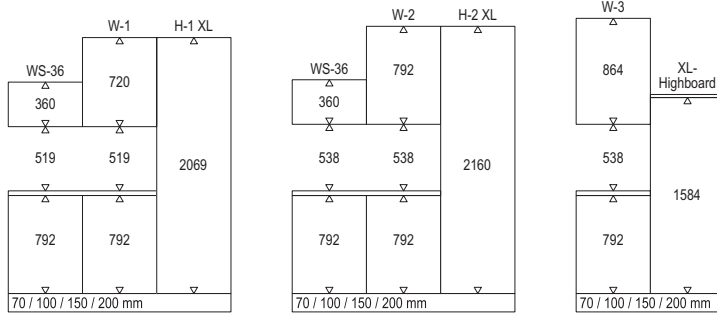

Height grid, standard and maxi door dimensions

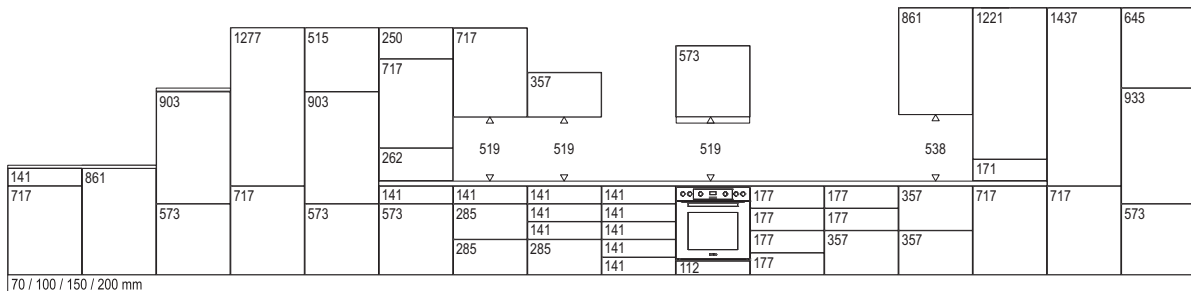

Height grid, standard and maxi door dimensions

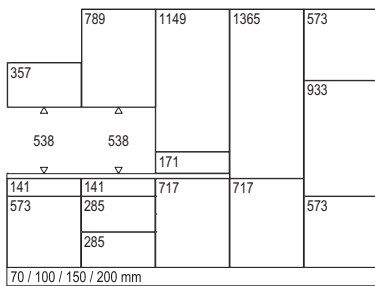

Height grid, XL door dimensions

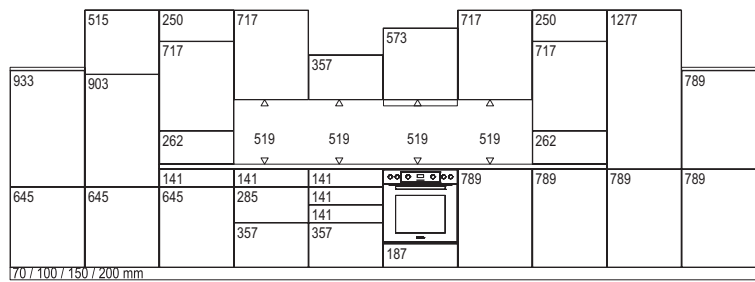

Height grid, tall units

